

For enquiries email at info@sbsyscon.in or call at +91-9899598955/900



Our commitment is **your safe future**

Electrical Installations from A to Z
Price List w.e.f. 25th February, 2026

SIEMENS

For enquiries email at info@sbsyscon.in or call at +91-9899598955/900



The safe choice – **now made smarter**

SENTRON circuit protection devices with
communication and measuring function

siemens.com/circuit-protection

SIEMENS

Index



Sr. No.	Items	Pg. No.
1	Betagard Miniature Circuit Breakers	
	5SL6, 7.5kA with C characteristics	5
	5SL6, 7.5kA with B characteristics	6
	5SL4, 10kA with C characteristics	7
	5SL7, with C characteristics	8
	5SL7, with D characteristics	9
2	Betagard Circuit Breakers	
	5SL7, with K characteristics	13
	5SL4, with Z characteristics	14
	5SP4, 10kA with C and D characteristics	15
	Betagard Isolators 5TL1	15
3	Betagard DC Circuit Breakers	
	5SL5, 10kA DC with C characteristics	16
4	Betagard Residual Current Circuit Breakers	
	5SV RCCB - Type AC, Type A	18
5	SETRON Residual Current Units	
	5SM2..RC, RC Units - Type AC, Type A	20
	Accessories selection - Remote control mechanism	21
6	Betagard Residual Current Breaker Operators	
	5SU1 RCBO, 10kA, Type AC with C and D characteristics	22
	5SU1 RCBO, 10kA, Type A with C and D characteristics	23
7	Betagard Accessories	24
8	Opulenz	25
9	Arc Fault Detection Devices (AFDD)	26-27
10	SETRON COM Devices NEW	28
	5SV6 AFDD COM	29
	7KN Powercenter 1000	29
11	SINOPLUS 5TR4 ACCL	30
12	Betagard Distribution Boards	
	8GB32 SPN, TPN & Phase Segregated DBs	32-34
	Industrial Plug & Socket DBs, Simbox WP DBs	35
	Accessories for Betagard DBs	36
13	SINOPLUS Low Voltage Switchgears	37
14	SETRON Surge Protection Devices	
	Surge Protection Devices	39-41
15	SETRON Modular Devices	
	Insta contactors, Twilight switch	43
	Voltage relays, Indicators and Fuse monitors	44
	Time switches	45
16	Fuses with insulated gripping lugs - 3NA6	46
17	SINOPLUS MCCBs - 3VJ, RAJA+ Starters ordering info	47-49
18	Switch Disconnecter Fuses - 3KL and Fuses - 3NA/3NW ordering info	50
19	Available till stocks last	51-52
20	Discontinued products	53
21	Multi channel current measuring system	54-55
22	Technical Information	56-57
23	Customer Care	58

Betagard 5SL MCBs – Inspiring Safety



Unique SLR (Slide Latch-Release) feature for tool free removal from DIN rail allows individual MCB to be removed from bus bar mounted assembly without disturbing other devices

BIS approval for ISI marking as per latest IS/IEC 60898-1:2015 for assured quality and protection







Unique termination mechanism enables firm mounting of Bus bar together with wire; and provides front access to wires for safe installation

Betagard Miniature Circuit Breakers 5SL6, with C Characteristics



- Standards: IS/IEC 60898-1:2015
- Voltage: Un 240/415V, 50...60Hz[^]
- With ISI marking: CM/L No. 2255548

7500A	Rated Current I _n (A)	MW#	Reference No	Unit MRP* ₹	Std. Pkg.** (Nos.)
	1P, 240/415V AC	1	5SL61057RC	606.-	1/12
	0.5	1	5SL61017RC	606.-	1/12
	1	1	5SL61027RC	606.-	1/12
	2	1	5SL61037RC	606.-	1/12
	3	1	5SL61047RC	606.-	1/12
	4	1	5SL61067RC	376.-	1/12
	6	1	5SL61087RC	376.-	1/12
	8	1	5SL61107RC	376.-	1/12
	10	1	5SL61137RC	376.-	1/12
	13	1	5SL61167RC	376.-	1/12
	16	1	5SL61207RC	376.-	1/12
	20	1	5SL61257RC	376.-	1/12
	25	1	5SL61327RC	376.-	1/12
	32	1	5SL61407RC	826.-	1/12
	40	1	5SL61507RC	950.-	1/12
50	1	5SL61637RC	950.-	1/12	
63	1	5SL61637RC	950.-	1/12	
	2P, 415V AC	2	5SL62057RC	1793.-	1/6
	0.5	2	5SL62017RC	1793.-	1/6
	1	2	5SL62027RC	1793.-	1/6
	2	2	5SL62037RC	1793.-	1/6
	3	2	5SL62047RC	1793.-	1/6
	4	2	5SL62067RC	1342.-	1/6
	6	2	5SL62087RC	1342.-	1/6
	8	2	5SL62107RC	1342.-	1/6
	10	2	5SL62137RC	1342.-	1/6
	13	2	5SL62167RC	1342.-	1/6
	16	2	5SL62207RC	1342.-	1/6
	20	2	5SL62257RC	1342.-	1/6
	25	2	5SL62327RC	1342.-	1/6
	32	2	5SL62407RC	1883.-	1/6
	40	2	5SL62507RC	2210.-	1/6
50	2	5SL62637RC	2210.-	1/6	
63	2	5SL62637RC	2210.-	1/6	
	3P, 415V AC	3	5SL63057RC	2517.-	1/4
	0.5	3	5SL63017RC	2517.-	1/4
	1	3	5SL63027RC	2517.-	1/4
	2	3	5SL63047RC	2517.-	1/4
	4	3	5SL63067RC	2015.-	1/4
	6	3	5SL63107RC	2015.-	1/4
	10	3	5SL63167RC	2015.-	1/4
	16	3	5SL63207RC	2015.-	1/4
	20	3	5SL63257RC	2015.-	1/4
	25	3	5SL63327RC	2015.-	1/4
	32	3	5SL63407RC	2820.-	1/4
	40	3	5SL63507RC	3149.-	1/4
	50	3	5SL63637RC	3149.-	1/4
	63	3	5SL63637RC	3149.-	1/4
		4P, 415V AC	4	5SL64057RC	3475.-
0.5		4	5SL64017RC	3475.-	1/3
1		4	5SL64027RC	3475.-	1/3
2		4	5SL64047RC	3475.-	1/3
4		4	5SL64067RC	2786.-	1/3
6		4	5SL64107RC	2786.-	1/3
10		4	5SL64167RC	2786.-	1/3
16		4	5SL64207RC	2786.-	1/3
20		4	5SL64257RC	2786.-	1/3
25		4	5SL64327RC	2786.-	1/3
32		4	5SL64407RC	3600.-	1/3
40		4	5SL64507RC	4168.-	1/3
50		4	5SL64637RC	4168.-	1/3
63		4	5SL64637RC	4168.-	1/3

■ Stock items

Note:

* MRP - Maximum Retail Price

1MW (Module Width) = 18mm

** Purchase MOQ for our authorized dealers is in multiples of standard packing, contact Siemens Sales Office for further details





^ Suitable for DC networks in Telecom application; 60V DC for 1P & 110V DC for 2P (contact sales office for connection diagram)

Miniature Circuit Breakers



Betagard Miniature Circuit Breakers 5SL6, with B Characteristics

- Standards: IS/IEC 60898-1:2015
- Voltage: Un 240/415V, 50...60Hz
- With ISI marking: CM/L No. 225548

7500A	Rated Current I_n (A)	MW#	Reference No	Unit MRP* ₹	Std. Pkg.** (Nos.)
1P, 240/415V AC 	6	1	5SL61066RC	368.-	1/12
	10		5SL61106RC	368.-	1/12
	16		5SL61166RC	368.-	1/12
	20		5SL61206RC	368.-	1/12
	25		5SL61256RC	368.-	1/12
	32		5SL61326RC	368.-	1/12
	40		5SL61406RC	822.-	1/12
	50		5SL61506RC	923.-	1/12
	63		5SL61636RC	923.-	1/12
2P, 415V AC 	6	2	5SL62066RC	1327.-	1/6
	10		5SL62106RC	1327.-	1/6
	16		5SL62166RC	1327.-	1/6
	20		5SL62206RC	1327.-	1/6
	25		5SL62256RC	1327.-	1/6
	32		5SL62326RC	1327.-	1/6
	40		5SL62406RC	1866.-	1/6
	50		5SL62506RC	2192.-	1/6
	63		5SL62636RC	2192.-	1/6
3P, 415V AC 	6	3	5SL63066RC	2015.-	1/4
	10		5SL63106RC	2015.-	1/4
	16		5SL63166RC	2015.-	1/4
	20		5SL63206RC	2015.-	1/4
	25		5SL63256RC	2015.-	1/4
	32		5SL63326RC	2015.-	1/4
	40		5SL63406RC	2784.-	1/4
	50		5SL63506RC	3122.-	1/4
	63		5SL63636RC	3122.-	1/4
4P, 415V AC 	6	4	5SL64066RC	2771.-	1/3
	10		5SL64106RC	2771.-	1/3
	16		5SL64166RC	2771.-	1/3
	20		5SL64206RC	2771.-	1/3
	25		5SL64256RC	2771.-	1/3
	32		5SL64326RC	2771.-	1/3
	40		5SL64406RC	3458.-	1/3
	50		5SL64506RC	4156.-	1/3
	63		5SL64636RC	4156.-	1/3

■ Stock items

Note:

* MRP - Maximum Retail Price # 1MW (Module Width) = 18mm

** Purchase MOQ for our authorized dealers is in multiples of standard packing, contact Siemens Sales Office for further details







Miniature Circuit Breakers

Betagard Miniature Circuit Breakers 5SL4, with C characteristics



- Standards: IS/IEC 60898-1:2015
- Voltage: Un 240/415V, 50...60Hz^
- Breaking capacity: 10kA as per IS/IEC 60898-1
- With ISI marking: CM/L No. 2255548

10000A	Rated Current I _n (A)	MW#	Reference No	Unit MRP* ₹	Std. Pkg.** (Nos.)
	1P, 240/415V AC	1	5SL41057RC	703.-	1/12
	0.5	1	5SL41027RC	703.-	1/12
	2	1	5SL41037RC	703.-	1/12
	3	1	5SL41047RC	703.-	1/12
	4	1	5SL41067RC	455.-	1/12
	6	1	5SL41087RC	455.-	1/12
	8	1	5SL41107RC	455.-	1/12
	10	1	5SL41137RC	455.-	1/12
	13	1	5SL41167RC	455.-	1/12
	16	1	5SL41207RC	455.-	1/12
	20	1	5SL41257RC	455.-	1/12
	25	1	5SL41327RC	455.-	1/12
	32	1	5SL41407RC	991.-	1/12
	40	1	5SL41507RC	1021.-	1/12
50	1	5SL41637RC	1021.-	1/12	
63	1	5SL41637RC	1021.-	1/12	
	2P, 415V AC	2	5SL42057RC	2085.-	1/6
	0.5	2	5SL42027RC	2085.-	1/6
	2	2	5SL42037RC	2085.-	1/6
	3	2	5SL42047RC	2085.-	1/6
	4	2	5SL42067RC	1495.-	1/6
	6	2	5SL42087RC	1495.-	1/6
	8	2	5SL42107RC	1495.-	1/6
	10	2	5SL42137RC	1495.-	1/6
	13	2	5SL42167RC	1495.-	1/6
	16	2	5SL42207RC	1495.-	1/6
	20	2	5SL42257RC	1495.-	1/6
	25	2	5SL42327RC	1495.-	1/6
	32	2	5SL42407RC	2410.-	1/6
	40	2	5SL42507RC	2410.-	1/6
50	2	5SL42637RC	2410.-	1/6	
63	2	5SL42637RC	2410.-	1/6	
	3P, 415V AC	3	5SL43057RC	3369.-	1/4
	0.5	3	5SL43027RC	3369.-	1/4
	2	3	5SL43037RC	3369.-	1/4
	3	3	5SL43047RC	3369.-	1/4
	4	3	5SL43067RC	2510.-	1/4
	6	3	5SL43087RC	2510.-	1/4
	8	3	5SL43107RC	2510.-	1/4
	10	3	5SL43137RC	2510.-	1/4
	13	3	5SL43167RC	2510.-	1/4
	16	3	5SL43207RC	2510.-	1/4
	20	3	5SL43257RC	2510.-	1/4
	25	3	5SL43327RC	2510.-	1/4
	32	3	5SL43407RC	3798.-	1/4
	40	3	5SL43507RC	3798.-	1/4
50	3	5SL43637RC	3798.-	1/4	
63	3	5SL43637RC	3798.-	1/4	
	4P, 415V AC	4	5SL44057RC	4234.-	1/3
	0.5	4	5SL44027RC	4234.-	1/3
	2	4	5SL44037RC	4234.-	1/3
	3	4	5SL44047RC	4234.-	1/3
	4	4	5SL44067RC	3475.-	1/3
	6	4	5SL44087RC	3475.-	1/3
	8	4	5SL44107RC	3475.-	1/3
	10	4	5SL44137RC	3475.-	1/3
	13	4	5SL44167RC	3475.-	1/3
	16	4	5SL44207RC	3475.-	1/3
	20	4	5SL44257RC	3475.-	1/3
	25	4	5SL44327RC	3475.-	1/3
	32	4	5SL44407RC	4740.-	1/3
	40	4	5SL44507RC	4740.-	1/3
50	4	5SL44637RC	4740.-	1/3	
63	4	5SL44637RC	4740.-	1/3	

■ Stock items

Note: * MRP - Maximum Retail Price # 1MW (Module Width) = 18mm

** Purchase MOQ for our authorized dealers is in multiples of standard packing, contact Siemens Sales Office for further details





^ Suitable for DC networks in Telecom application; 60V DC for 1P & 110V DC for 2P (contact sales office for connection diagram)

Miniature Circuit Breakers

Betagard Miniature Circuit Breakers 5SL7, with C characteristics



- Standards: IS/IEC 60898-1:2015
- Voltage: Un 240/415V, 50...60Hz
- Breaking capacity: 15kA¹⁾ as per IS/IEC 60898-1
- With ISI marking: CM/L No. 2255548

	Rated Current I_n (A)	MW#	Reference No	Unit MRP* ₹	Std. Pkg.** (Nos.)
	0.5	1	5SL71057RC	805.-	1/12
	1		5SL71017RC	805.-	1/12
	2		5SL71027RC	790.-	1/12
	4		5SL71047RC	790.-	1/12
	6		5SL71067RC	680.-	1/12
	10		5SL71107RC	680.-	1/12
	16		5SL71167RC	680.-	1/12
	20		5SL71207RC	680.-	1/12
	25		5SL71257RC	680.-	1/12
	32		5SL71327RC	680.-	1/12
	40		5SL71407RC	1070.-	1/12
	50		5SL71507RC	1080.-	1/12
	63		5SL71637RC	1080.-	1/12
	0.5	2	5SL72057RC	2285.-	1/6
	1		5SL72017RC	2285.-	1/6
	2		5SL72027RC	2240.-	1/6
	4		5SL72047RC	2240.-	1/6
	6		5SL72067RC	1630.-	1/6
	10		5SL72107RC	1630.-	1/6
	16		5SL72167RC	1630.-	1/6
	20		5SL72207RC	1630.-	1/6
	25		5SL72257RC	1630.-	1/6
	32		5SL72327RC	1630.-	1/6
	40		5SL72407RC	2455.-	1/6
	50		5SL72507RC	2455.-	1/6
	63		5SL72637RC	2455.-	1/6
	0.5	3	5SL73057RC	3500.-	1/4
	1		5SL73017RC	3500.-	1/4
	2		5SL73027RC	3440.-	1/4
	4		5SL73047RC	3440.-	1/4
	6		5SL73067RC	2595.-	1/4
	10		5SL73107RC	2595.-	1/4
	16		5SL73167RC	2595.-	1/4
	20		5SL73207RC	2595.-	1/4
	25		5SL73257RC	2595.-	1/4
	32		5SL73327RC	2595.-	1/4
	40		5SL73407RC	3870.-	1/4
	50		5SL73507RC	3870.-	1/4
	63		5SL73637RC	3870.-	1/4
	0.5	4	5SL74057RC	4415.-	1/3
	1		5SL74017RC	4415.-	1/3
	2		5SL74027RC	4335.-	1/3
	4		5SL74047RC	4335.-	1/3
	6		5SL74067RC	3470.-	1/3
	10		5SL74107RC	3470.-	1/3
	16		5SL74167RC	3470.-	1/3
	20		5SL74207RC	3470.-	1/3
	25		5SL74257RC	3470.-	1/3
	32		5SL74327RC	3470.-	1/3
	40		5SL74407RC	4865.-	1/3
	50		5SL74507RC	4865.-	1/3
	63		5SL74637RC	4865.-	1/3

Note:

* MRP - Maximum Retail Price # 1MW (Module Width) = 18mm





** Purchase MOQ for our authorized dealers is in multiples of standard packing, contact Siemens Sales Office for further details

¹⁾ Breaking capacity 63A - 10kA

Betagard Miniature Circuit Breakers 5SL7, with D characteristics



- Standards: IS/IEC 60898-1
- Voltage: Un 240/415V, 50...60Hz
- Breaking capacity: 15kA¹⁾ as per IS/IEC 60898-1
- With ISI marking: CM/L No. 2255548

	Rated Current I_n (A)	MW#	Reference No	Unit MRP* ₹	Std. Pkg.** (Nos.)
1P, 240/415V AC 	0.5	1	5SL71058RC	815.-	1/12
	1		5SL71018RC	815.-	1/12
	2		5SL71028RC	790.-	1/12
	4		5SL71048RC	790.-	1/12
	6		5SL71068RC	705.-	1/12
	10		5SL71108RC	705.-	1/12
	16		5SL71168RC	705.-	1/12
	20		5SL71208RC	705.-	1/12
	25		5SL71258RC	705.-	1/12
	32		5SL71328RC	705.-	1/12
	40		5SL71408RC	1375.-	1/12
	50		5SL71508RC	1375.-	1/12
	63		5SL71638RC	1375.-	1/12
2P, 415V AC 	0.5	2	5SL72058RC	2320.-	1/6
	1		5SL72018RC	2320.-	1/6
	2		5SL72028RC	2240.-	1/6
	4		5SL72048RC	2240.-	1/6
	6		5SL72068RC	1725.-	1/6
	10		5SL72108RC	1725.-	1/6
	16		5SL72168RC	1725.-	1/6
	20		5SL72208RC	1725.-	1/6
	25		5SL72258RC	1725.-	1/6
	32		5SL72328RC	1725.-	1/6
	40		5SL72408RC	3175.-	1/6
	50		5SL72508RC	3175.-	1/6
	63		5SL72638RC	3175.-	1/6
3P, 415V AC 	0.5	3	5SL73058RC	3570.-	1/4
	1		5SL73018RC	3570.-	1/4
	2		5SL73028RC	3440.-	1/4
	4		5SL73048RC	3440.-	1/4
	6		5SL73068RC	2730.-	1/4
	10		5SL73108RC	2730.-	1/4
	16		5SL73168RC	2730.-	1/4
	20		5SL73208RC	2730.-	1/4
	25		5SL73258RC	2730.-	1/4
	32		5SL73328RC	2730.-	1/4
	40		5SL73408RC	4945.-	1/4
	50		5SL73508RC	4945.-	1/4
	63		5SL73638RC	4945.-	1/4
4P, 415V AC 	0.5	4	5SL74058RC	4565.-	1/3
	1		5SL74018RC	4565.-	1/3
	2		5SL74028RC	4405.-	1/3
	4		5SL74048RC	4405.-	1/3
	6		5SL74068RC	3605.-	1/3
	10		5SL74108RC	3605.-	1/3
	16		5SL74168RC	3605.-	1/3
	20		5SL74208RC	3605.-	1/3
	25		5SL74258RC	3605.-	1/3
	32		5SL74328RC	3605.-	1/3
	40		5SL74408RC	6215.-	1/3
	50		5SL74508RC	6215.-	1/3
	63		5SL74638RC	6215.-	1/3

Note:

* MRP - Maximum Retail Price # 1MW (Module Width) = 18mm

** Purchase MOQ for our authorized dealers is in multiples of standard packing, contact Siemens Sales Office for further details

¹⁾ Breaking capacity 40A - 63A: 10kA

DISCOVER THE POWER OF SIMPLICITY

SINOPLUS 5TJ MCB

NEW

IEC

Safe
Complies with
IEC standards



Comprehensive
range
For various
applications



Reliable
Siemens trusted
quality



RoHS
compliance
Environmentally
friendly

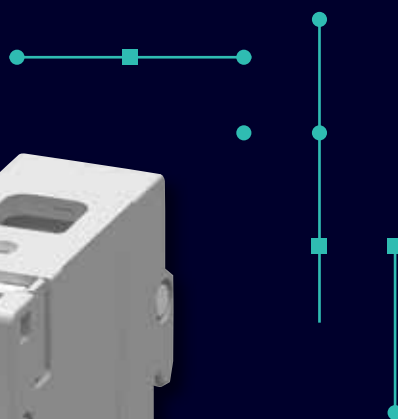
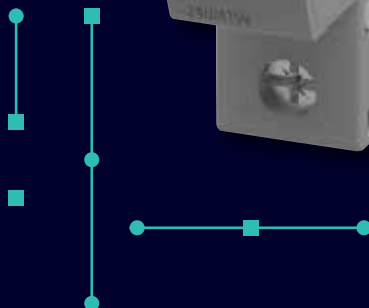
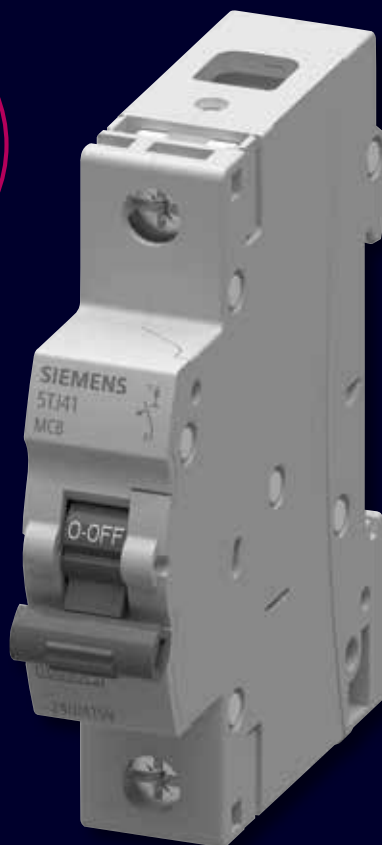

www.siemens.co.in

Learn more about our
low-voltage electrical
products or contact
us for a personalized
consultation and take
the first step towards
an efficient power
future.



SIEMENS

DISCOVER THE POWER OF **SIMPLICITY**

SINOPLUS low-voltage electrical products



Cost-effective
Best price
performance
ratio



Comprehensive
range
For various
applications



Reliable
Siemens trusted
quality

IEC

Safe
Complies with
IEC standards



www.siemens.co.in

Learn more about our low-voltage electrical products or contact us for a personalized consultation and take the first step towards an efficient power future.



SIEMENS



5SL Circuit Breaker - K & Z Curve



"K" Characteristic Trip Curve:

MCB trips instantaneously when the current flowing through it reaches between 10 to 14 times the rated current.

Suitable for inductive and motor loads with high inrush currents; etc

"Z" Characteristic Trip Curve:

MCB trips when the current flowing through it reaches between 2 to 3 times the rated current, highly sensitive to short circuit current

Suitable for the protection of highly sensitive devices such as semiconductor devices,





- In compliance with standards IEC 60947-2
- Range available from 2A – 63A
- Comprehensive features & accessories in line with 5SL MCB
- For protection in Industrial, Infrastructure, Process Automation, Commercial applications

Betagard Circuit Breakers
5SL7, with K characteristics



L - 7500266715

- Standards: IS/IEC 60947-2:2016
- Voltage: Un 240/415V, 50...60Hz
- Breaking capacity (Icu): 15kA¹⁾ as per IS/IEC 60947-2

	Rated Current I _n (A)	MW#	Reference No	Unit MRP* ₹	Std. Pkg.** (Nos.)
1P, 240/415V AC 	2	1	5SL71023RC	705.-	1/12
	4		5SL71043RC	705.-	1/12
	6		5SL71063RC	630.-	1/12
	10		5SL71103RC	625.-	1/12
	16		5SL71163RC	630.-	1/12
	20		5SL71203RC	625.-	1/12
	25		5SL71253RC	630.-	1/12
	32		5SL71323RC	630.-	1/12
	40		5SL71403RC	1105.-	1/12
	63		5SL71633RC	1300.-	1/12
2P, 415V AC 	2	2	5SL72023RC	2145.-	1/6
	4		5SL72043RC	2145.-	1/6
	6		5SL72063RC	1990.-	1/6
	10		5SL72103RC	1945.-	1/6
	16		5SL72163RC	1990.-	1/6
	20		5SL72203RC	1945.-	1/6
	25		5SL72253RC	1990.-	1/6
	32		5SL72323RC	1990.-	1/6
	40		5SL72403RC	2400.-	1/6
	63		5SL72633RC	2760.-	1/6
3P, 415V AC 	2	3	5SL73023RC	3335.-	1/4
	4		5SL73043RC	3335.-	1/4
	6		5SL73063RC	3050.-	1/4
	10		5SL73103RC	2985.-	1/4
	16		5SL73163RC	3050.-	1/4
	20		5SL73203RC	2985.-	1/4
	25		5SL73253RC	3050.-	1/4
	32		5SL73323RC	3050.-	1/4
	40		5SL73403RC	3395.-	1/4
	63		5SL73633RC	3815.-	1/4
4P, 415V AC 	2	4	5SL74023RC	4255.-	1/3
	4		5SL74043RC	4255.-	1/3
	6		5SL74063RC	4020.-	1/3
	10		5SL74103RC	3930.-	1/3
	16		5SL74163RC	4020.-	1/3
	20		5SL74203RC	3930.-	1/3
	25		5SL74253RC	4020.-	1/3
	32		5SL74323RC	4020.-	1/3
	40		5SL74403RC	4385.-	1/3
	63		5SL74633RC	4935.-	1/3

Note:

* MRP - Maximum Retail Price # 1MW (Module Width) = 18mm

** Purchase MOQ for our authorized dealers is in multiples of standard packing, contact Siemens Sales Office for further details



¹⁾ Breaking capacity 40A - 63A: 10kA

Betagard Circuit Breakers 5SL4, with Z characteristics



L - 7500266715

- Standards: IS/IEC 60947-2:2016
- Voltage: Un 240/415V, 50...60Hz
- Breaking capacity (Icu): 15kA¹⁾ as per IS/IEC 60947-2

	Rated Current I _n (A)	MW#	Reference No	Unit MRP* ₹	Std. Pkg.** (Nos.)
1P, 240/415V AC 	2	1	5SL41020RC	965.-	1/12
	4		5SL41040RC	965.-	1/12
	6		5SL41060RC	758.-	1/12
	10		5SL41100RC	758.-	1/12
	16		5SL41160RC	758.-	1/12
	20		5SL41200RC	758.-	1/12
	25		5SL41250RC	758.-	1/12
	32		5SL41320RC	758.-	1/12
	40		5SL41400RC	999.-	1/12
	63		5SL41630RC	999.-	1/12
2P, 415V AC 	2	2	5SL42020RC	1895.-	1/6
	4		5SL42040RC	1895.-	1/6
	6		5SL42060RC	1788.-	1/6
	10		5SL42100RC	1788.-	1/6
	16		5SL42160RC	1788.-	1/6
	20		5SL42200RC	1788.-	1/6
	25		5SL42250RC	1788.-	1/6
	32		5SL42320RC	1788.-	1/6
	40		5SL42400RC	2074.-	1/6
	63		5SL42630RC	2074.-	1/6
3P, 415V AC 	2	3	5SL43020RC	3003.-	1/4
	4		5SL43040RC	3003.-	1/4
	6		5SL43060RC	2501.-	1/4
	10		5SL43100RC	2501.-	1/4
	16		5SL43160RC	2501.-	1/4
	20		5SL43200RC	2501.-	1/4
	25		5SL43250RC	2501.-	1/4
	32		5SL43320RC	2501.-	1/4
	40		5SL43400RC	3146.-	1/4
	63		5SL43630RC	3146.-	1/4
4P, 415V AC 	2	4	5SL44020RC	3253.-	1/3
	4		5SL44040RC	3253.-	1/3
	6		5SL44060RC	2825.-	1/3
	10		5SL44100RC	2825.-	1/3
	16		5SL44160RC	2825.-	1/3
	20		5SL44200RC	2825.-	1/3
	25		5SL44250RC	2825.-	1/3
	32		5SL44320RC	2825.-	1/3
	40		5SL44400RC	3546.-	1/3
	63		5SL44630RC	3546.-	1/3

Note:

* MRP - Maximum Retail Price # 1MW (Module Width) = 18mm

** Purchase MOQ for our authorized dealers is in multiples of standard packing, contact Siemens Sales Office for further details

Betagard Miniature Circuit Breakers 5SP4, with C/D characteristics



- Standards: IS/IEC 60898-1:2015
- Voltage: Un 240/415V
- Breaking capacity: 10kA as per IS/IEC 60898-1:2015
- With ISI marking: CM/L No. 2255548

C characteristic

10000A		Rated Current I_n (A)	MW#	Reference No	Unit MRP* ₹	Std. Pkg.** (Nos.)
	1-pole	80	1.5	5SP41807RC	5095.-	1/10
		100		5SP41917RC	5370.-	1/10
		125		5SP41927RC	6095.-	1/10
	2-pole	80	3	5SP42807RC	10000.-	1/5
		100		5SP42917RC	10540.-	1/5
		125		5SP42927RC	11930.-	1/5
	3-pole	80	4.5	5SP43807RC	15610.-	1/1
		100		5SP43917RC	16020.-	1/1
		125		5SP43927RC	18360.-	1/1
	4-pole	80	6	5SP44807RC	22390.-	1/1
		100		5SP44917RC	23035.-	1/1
		125		5SP44927RC	26225.-	1/1

D characteristic

	1-pole	80	1.5	5SP41808RC	5610.-	1/10
		100		5SP41918RC	5880.-	1/10
	2-pole	80	3	5SP42808RC	11260.-	1/5
		100		5SP42918RC	11935.-	1/5
	3-pole	80	4.5	5SP43808RC	17340.-	1/1
		100		5SP43918RC	17520.-	1/1
	4-pole	80	6	5SP44808RC	24385.-	1/1
100	5SP44918RC	25015.-		1/1		

Betagard Isolators 5TL1

- Standard: IS/IEC 60947-3
- Voltage: 440V AC

		Rated Current I_n (A)	MW#	Reference No	Unit MRP* ₹	Std. Pkg.** (Nos.)
	2-pole	40	2	5TL12400	1135.-	1/1
		63		5TL12630	1490.-	1/1
		80		5TL12800	1955.-	1/1
		100		5TL12910	2480.-	1/1
		125		5TL12920	2590.-	1/1
	3-pole	40	3	5TL13400	2105.-	1/1
		63		5TL13630	2365.-	1/1
		80		5TL13800	2855.-	1/1
		100		5TL13910	3005.-	1/1
		125		5TL13920	3245.-	1/1
	4-pole	40	4	5TL14400	2470.-	1/1
		63		5TL14630	2815.-	1/1
		80		5TL14800	3390.-	1/1
		100		5TL14910	4070.-	1/1
		125		5TL14920	4405.-	1/1



Note:

* MRP - Maximum Retail Price

** Purchase MOQ for our authorized dealers is in multiples of standard packing, contact Siemens Sales Office for further details

Betagard Circuit Breakers 5SL5, DC with C Characteristics

- Standards: IS/IEC 60947-2:2016
- Voltage: 220V DC/1P, 440V DC/2P & 880V DC/4P[^]
- Breaking capacity: 10kA as per IS/IEC 60947-2

10000A	Rated Current I_n (A)	MW#	Reference No	Unit MRP* ₹	Std. Pkg.** (Nos.)
	1P, 220V DC	1	5SL51057RC	1210.-	1/12
	0.5		5SL51017RC	1210.-	1/12
	1		5SL51027RC	1305.-	1/12
	2		5SL51037RC	1365.-	1/12
	3		5SL51047RC	1305.-	1/12
	4		5SL51067RC	1105.-	1/12
	6		5SL51087RC	1170.-	1/12
	8		5SL51107RC	1105.-	1/12
	10		5SL51167RC	1105.-	1/12
	16		5SL51207RC	1105.-	1/12
	20		5SL51257RC	1105.-	1/12
	25		5SL51327RC	1105.-	1/12
	32		5SL51407RC	1655.-	1/12
	40		5SL51507RC	1655.-	1/12
50		5SL51637RC	1655.-	1/12	
63					
	2P, 440V DC	2	5SL52057RC	2630.-	1/6
	0.5		5SL52017RC	2630.-	1/6
	1		5SL52027RC	2630.-	1/6
	2		5SL52037RC	2755.-	1/6
	3		5SL52047RC	2630.-	1/6
	4		5SL52067RC	2305.-	1/6
	6		5SL52087RC	2420.-	1/6
	8		5SL52107RC	2305.-	1/6
	10		5SL52167RC	2305.-	1/6
	16		5SL52207RC	2305.-	1/6
	20		5SL52257RC	2305.-	1/6
	25		5SL52327RC	2305.-	1/6
	32		5SL52407RC	3410.-	1/6
	40		5SL52507RC	3410.-	1/6
50		5SL52637RC	3410.-	1/6	
63					
	4P, 880V DC ¹⁾	4	5SL54067RC	4660.-	1/3
	6		5SL54107RC	4660.-	1/3
	10		5SL54167RC	4660.-	1/3
	16		5SL54257RC	4955.-	1/3
	25		5SL54327RC	4955.-	1/3
	32		5SL54407RC	5825.-	1/3
	40		5SL54637RC	6110.-	1/3
63					

■ Stock items

1) maximum operational voltage 1000V DC

^ For connection diagram, contact Siemens Sales Office for further details.

• Also available DC Circuit Breakers for Solar applications - contact Siemens sales office for further details.

Note:

* MRP - Maximum Retail Price # 1MW (Module Width) = 18mm

** Purchase MOQ for our authorized dealers is in multiples of standard packing, contact Siemens Sales Office for further details

Betagard 5SV

Residual Current Circuit Breakers



In the event of a fault,
residual current protective
devices reliably disconnect
power to protect humans

Fault protection

“Protection against indirect contact”

Protects people in the event of contact with electrically conductive parts, if a risk exists as a result of a fault due to the magnitude or duration of the touch voltage



Additional protection

“Protection in case of direct contact” with $I_{\Delta n} = 30\text{mA}$

Protects individuals if they come in direct contact with an active live part under normal operating condition



Fire protection

“Protection from insulation faults” with $I_{\Delta n} = 300\text{mA}$

For the prevention of fires which can be caused by insulation faults in locations exposed to fire hazards



Surge current withstand capability

“Protection surge currents” with $8/20\mu\text{s} > 1000\text{Amp}$

For Type “A”  have a surge current capability to avoid nuisance tripping









Betagard Residual Current Circuit Breakers 5SV

- Standards: IS 12640 (Part 1):2016/ IEC 61008-1:2012
- Voltage: 240/415V AC, 50Hz
- With ISI marking: CM/L No. 7676092

Type AC, applicable in networks for AC residual currents

	Rated residual current $I_{\Delta n}$ (mA)	Rated Current I_n (A)	MW#	Reference No	Unit MRP* ₹	Std. Pkg.** (Nos.)	
	2 Pole	30	25	2	5SV43120RC	5225.-	1
		100	25		5SV44120RC	5720.-	1
		300	25		5SV46120RC	5915.-	1
		30	40		5SV43140RC	6125.-	1
		100	40		5SV44140RC	6705.-	1
		300	40		5SV46140RC	6960.-	1
		30	63		5SV43160RC	8195.-	1
		100	63		5SV44160RC	8645.-	1
		300	63		5SV46160RC	9190.-	1
		30	80		5SV43170RC	13265.-	1
		100	80		5SV44170RC	13800.-	1
		300	80		5SV46170RC	13800.-	1
	4 Pole	30	25	4	5SV43420RC	7335.-	1
		100	25		5SV44420RC	7605.-	1
		300	25		5SV46420RC	7880.-	1
		30	40		5SV43440RC	7420.-	1
		100	40		5SV44440RC	7705.-	1
		300	40		5SV46440RC	8005.-	1
		30	63		5SV43460RC	8645.-	1
		100	63		5SV44460RC	8995.-	1
		300	63		5SV46460RC	9310.-	1
		30	80		5SV43470RC	13265.-	1
		100	80		5SV44470RC	13800.-	1
		300	80		5SV46470RC	13800.-	1

Type A, applicable in networks with AC and/or pulsating DC residual currents

	2 Pole	30	25	2	5SV33126RC	10015.-	1
		100	25		5SV34126RC	11805.-	1
		300	25		5SV36126RC	11805.-	1
		30	40		5SV33146RC	11360.-	1
		100	40		5SV34146RC	11830.-	1
		300	40		5SV36146RC	11830.-	1
		30	63		5SV33166RC	16515.-	1
		100	63		5SV34166RC	16985.-	1
		300	63		5SV36166RC	16170.-	1
		30	80		5SV33176RC	17765.-	1
		100	80		5SV34176RC	19105.-	1
		300	80		5SV36176RC	18195.-	1
	4 Pole	30	25	4	5SV33426RC	11870.-	1
		100	25		5SV34426RC	14650.-	1
		300	25		5SV36426RC	14650.-	1
		30	40		5SV33446RC	13240.-	1
		100	40		5SV34446RC	14795.-	1
		300	40		5SV36446RC	14650.-	1
		30	63		5SV33466RC	14980.-	1
		100	63		5SV34466RC	14880.-	1
		300	63		5SV36466RC	14880.-	1
		30	80		5SV33476RC	18005.-	1
		100	80		5SV34476RC	19105.-	1
		300	80		5SV36476RC	18195.-	1

■ Stock items

Note:

* MRP - Maximum Retail Price # 1MW (Module Width) = 18mm

** Purchase MOQ for our authorized dealers is in multiples of standard packing, contact Siemens Sales Office for further details

SENTRON 5SM2

Residual Current Units



RC Units suitable with 5SL7..RC MCBs for complete protection from Residual current, Over load and Short circuit faults



Easy and Fast Installation



Reduced Inventory with range up to 63A in two variants only

Wide portfolio catering to various applications



Confirming to
- IEC/EN 61009-1
- IEC/EN 61009-2-1
- IEC/EN 61543





RoHS compliant





SENTRON Residual Current Units 5SM2

- Standards: In accordance with IEC/EN 61009-1 (VDE 0664-20), IEC/EN 61009-2-1 (VDE 0664-21), IEC/EN 61543 (VDE 0664-30)
- Voltage: 240/415V AC, 50Hz

Type AC, applicable in networks for AC residual currents

	Number of poles	Mounting width MW#	Rated residual current I Δ n [mA]	RC Unit-Current Rating [A]	5SL7..RC MCBs- Rated current [A]	Reference No	Unit LP* ₹	Std. Pkg.** (Nos.)
	2	2	10	40	2- 40	5SM21210RC	4915.-	1
			30	40	2- 40	5SM23220RC	5225.-	1
				63	2- 63	5SM23250RC	8585.-	1
			100	40	2- 40	5SM24220RC	6445.-	1
				63	2- 63	5SM24250RC	9350.-	1
	3	3	30	40	2- 40	5SM23320RC	5880.-	1
				63	2- 63	5SM23350RC	8860.-	1
			100	40	2- 40	5SM24320RC	7010.-	1
				63	2- 63	5SM24350RC	9655.-	1
			300	40	2- 40	5SM26320RC	7320.-	1
	63	2- 63	5SM26350RC	9875.-	1			
	4	3	30	40	2- 40	5SM23420RC	6390.-	1
				63	2- 63	5SM23450RC	9485.-	1
			100	40	2- 40	5SM24420RC	7465.-	1
				63	2- 63	5SM24450RC	9845.-	1
			300	40	2- 40	5SM26420RC	7770.-	1
	63	2- 63	5SM26450RC	10070.-	1			

Type A, applicable in networks with AC and/or pulsating DC residual currents

	Number of poles	Mounting width MW#	Rated residual current I Δ n [mA]	RC Unit-Current Rating [A]	5SL7..RC MCBs- Rated current [A]	Reference No	Unit LP* ₹	Std. Pkg.** (Nos.)
	2	2	10	40	2- 40	5SM21216RC	5005.-	1
			30	40	2- 40	5SM23226RC	5240.-	1
				63	2- 63	5SM23256RC	8915.-	1
			100	40	2- 40	5SM24226RC	7010.-	1
				63	2- 63	5SM24256RC	9355.-	1
	3	3	30	40	2- 40	5SM23326RC	5940.-	1
				63	2- 63	5SM23356RC	9095.-	1
			100	40	2- 40	5SM24326RC	7090.-	1
				63	2- 63	5SM24356RC	9895.-	1
			300	40	2- 40	5SM26326RC	7390.-	1
	63	2- 63	5SM26356RC	10120.-	1			
	4	3	30	40	2- 40	5SM23426RC	7135.-	1
				63	2- 63	5SM23456RC	9600.-	1
			100	40	2- 40	5SM24426RC	7745.-	1
				63	2- 63	5SM24456RC	10080.-	1
			300	40	2- 40	5SM26426RC	8075.-	1
	63	2- 63	5SM26456RC	10380.-	1			

■ Stock items

Note: * LP - List Price

1MW (Module Width) = 18mm

** Purchase MOQ for our authorized dealers is in multiples of standard packing, contact Siemens Sales Office for further details

**Note: To be used along with 5SL7..RC MCBs. MCBs to be ordered separately.
For MCB prices, refer Page no. 8 & 9 from this pricelist.**

Accessories for Remote control mechanism units for 5SM2 RC Units

Remote control mechanism unit:

Adapter- Mount-on device for combination of RC Units 5SM2..RC and MCBs 5SL7..RC.

Item Description	Mounting width MW#	Reference No	Std. Pkg. ** (Nos.)
RC Mech. Power- 5ST3055 & RC Mech. ARD*- 5ST3057 For 2P- 12 V -30 V AC 12 V -48V DC	2	5ST3820-3 + 5ST3820-6	1
RC Mech. Power- 5ST3055 & RC Mech. ARD*- 5ST3057 For 3P & 4P- 12 V -30 V AC 12 V -48V DC	2	5ST3820-3 + 5ST3820-7	1
RC Mech. Power- 5ST3056 & RC Mech. ARD*- 5ST3058 For 2P- 230 V AC	2	5ST3820-3 + 5ST3820-6	1
RC Mech. Power- 5ST3056 & RC Mech. ARD*- 5ST3058 For 3P & 4P- 230 V AC	2	5ST3820-3 + 5ST3820-7	1
RC Mech. Power- 5ST3070 For 2P- 12 V -30 V AC 12 V -48V DC	2	5ST3820-3 + 5ST3820-6	1
RC Mech. Power- 5ST3070 For 3P & 4P- 12 V -30 V AC 12 V -48V DC	2	5ST3820-3 + 5ST3820-7	1

*- Auto Reclose Device

1MW (Module Width) = 18mm

** Purchase MOQ for our authorized dealers is in multiples of standard packing, contact Siemens Sales Office for further details

Note: All accessories can be mounted on the right-hand side of the RC Unit+MCB assembled device.

Note: For pricing details of above mentioned MLFBs and for other 5SM2 accessories, Pl refer Page No. 24 of this Pricelist.





Betagard Residual Current Breaker Operators 5SU1, 10kA

- Standards: IS 12640, Part 2:2016/ IEC 61009-1:2012
- Voltage: 240/415V AC, 50Hz
- With ISI marking: CM/L No. 7676193



Type AC, with C Characteristics (in 2 module size)⁵

	Rated residual current $I_{\Delta n}$ (mA)	Rated Current I_n (A)	MW#	Reference No	Unit MRP* ₹	Std. Pkg.** (Nos.)	
	240V AC; 50Hz; 2 pole ¹⁾	30	6	2	5SU13541RC06	9310.-	1
		30	10		5SU13541RC10	9310.-	1
		30	16		5SU13541RC16	9310.-	1
		30	20		5SU13541RC20	9310.-	1
		30	25		5SU13541RC25	9310.-	1
		30	32		5SU13541RC32	9775.-	1
		30	40		5SU13541RC40	11550.-	1
		300	6		5SU16541RC06	9475.-	1
		300	10		5SU16541RC10	9475.-	1
		300	16		5SU16541RC16	9475.-	1
		300	20		5SU16541RC20	9475.-	1
		300	25		5SU16541RC25	9475.-	1
		300	32		5SU16541RC32	9970.-	1
		300	40		5SU16541RC40	11780.-	1

Type AC with C characteristic

	240V AC; 50Hz; 2 pole	30	32	4	5SU13241RC32	10570.-	1
			40		5SU13241RC40	12315.-	1
			63		5SU13241RC63	14310.-	1
		100	32		5SU14241RC32	11665.-	1
			40		5SU14241RC40	13110.-	1
			63		5SU14241RC63	15285.-	1
		300	32		5SU16241RC32	11780.-	1
			40		5SU16241RC40	13240.-	1
			63		5SU16241RC63	15285.-	1
	415V AC; 50Hz; 4 pole	30	32	7	5SU13441RC32	14115.-	1
			40		5SU13441RC40	14370.-	1
			63		5SU13441RC63	17055.-	1
		100	32		5SU14441RC32	14290.-	1
			40		5SU14441RC40	14565.-	1
			63		5SU14441RC63	16740.-	1
		300	32		5SU16441RC32	14405.-	1
			40		5SU16441RC40	14685.-	1
			63		5SU16441RC63	16895.-	1

Type AC with D characteristic

	240V AC; 50Hz; 2 pole	30	32	4	5SU13242RC32	13630.-	1
			40		5SU13242RC40	14935.-	1
			63		5SU13242RC63	18000.-	1
		100	32		5SU14242RC32	16495.-	1
			40		5SU14242RC40	18050.-	1
			63		5SU14242RC63	20615.-	1
		300	32		5SU16242RC32	16115.-	1
			40		5SU16242RC40	18050.-	1
			63		5SU16242RC63	20640.-	1
	415V AC; 50Hz; 4 pole	30	32	7	5SU13442RC32	18665.-	1
			40		5SU13442RC40	18940.-	1
			63		5SU13442RC63	22470.-	1
		100	32		5SU14442RC32	20200.-	1
			40		5SU14442RC40	21105.-	1
			63		5SU14442RC63	23405.-	1
		300	32		5SU16442RC32	19960.-	1
			40		5SU16442RC40	21305.-	1
			63		5SU16442RC63	22915.-	1

Note: * MRP - Maximum Retail Price # 1MW (Module Width) = 18mm ¹⁾ 1P+N variant

** Purchase MOQ for our authorized dealers is in multiples of standard packing, contact Siemens Sales Office for further details

\$ For connecting accessories with 2P 2M RCBO add handle connector 5ST38051

Betagard Residual Current Breaker Operators 5SU1, 10kA





- Standards: IS 12640, Part 2:2016/ IEC 61009-1:2012
- Voltage: 240/415V AC, 50Hz
- With ISI marking: CM/L No. 7676193



Type A, with C Characteristics (in 2 module size)[§]

	Rated residual current $I_{\Delta n}$ (mA)	Rated Current I_n (A)	MW#	Reference No	Unit MRP* ₹	Std. Pkg.** (Nos.)	
	240V AC; 50Hz; 2 pole ¹⁾	30	6	2	5SU13547RC06	17005.-	1
		30	10		5SU13547RC10	17005.-	1
		30	16		5SU13547RC16	17005.-	1
		30	20		5SU13547RC20	17005.-	1
		30	25		5SU13547RC25	17005.-	1
		30	32		5SU13547RC32	17775.-	1
		30	40		5SU13547RC40	21505.-	1
		300	6		5SU16547RC06	17505.-	1
		300	10		5SU16547RC10	17505.-	1
		300	16		5SU16547RC16	17505.-	1
		300	20		5SU16547RC20	17505.-	1
		300	25		5SU16547RC25	17505.-	1
		300	32		5SU16547RC32	18210.-	1
		300	40		5SU16547RC40	21955.-	1

Type A with C characteristic

	240V AC; 50Hz; 2 pole	30	32	4	5SU13247RC32	19150.-	1
			40		5SU13247RC40	21065.-	1
			63		5SU13247RC63	23830.-	1
		100	32		5SU14247RC32	20435.-	1
			40		5SU14247RC40	22700.-	1
			63		5SU14247RC63	25790.-	1
		300	32		5SU16247RC32	20435.-	1
			40		5SU16247RC40	22700.-	1
			63		5SU16247RC63	25790.-	1
	415V AC; 50Hz; 4 pole	30	32	7	5SU13447RC32	23435.-	1
			40		5SU13447RC40	24405.-	1
			63		5SU13447RC63	27925.-	1
		100	32		5SU14447RC32	25155.-	1
			40		5SU14447RC40	25630.-	1
			63		5SU14447RC63	28650.-	1
		300	32		5SU16447RC32	25155.-	1
			40		5SU16447RC40	26070.-	1
			63		5SU16447RC63	29095.-	1

Type A with D characteristic

	240V AC; 50Hz; 2 pole	30	32	4	5SU13248RC32	22340.-	1
			40		5SU13248RC40	25220.-	1
			63		5SU13248RC63	28690.-	1
		100	32		5SU14248RC32	24035.-	1
			40		5SU14248RC40	26735.-	1
			63		5SU14248RC63	30465.-	1
		300	32		5SU16248RC32	24035.-	1
			40		5SU16248RC40	26735.-	1
			63		5SU16248RC63	30465.-	1
	415V AC; 50Hz; 4 pole	30	32	7	5SU13448RC32	27660.-	1
			40		5SU13448RC40	28005.-	1
			63		5SU13448RC63	33035.-	1
		100	32		5SU14448RC32	29140.-	1
			40		5SU14448RC40	31135.-	1
			63		5SU14448RC63	33895.-	1
		300	32		5SU16448RC32	29140.-	1
			40		5SU16448RC40	31135.-	1
			63		5SU16448RC63	33900.-	1





Note: * MRP - Maximum Retail Price # 1MW (Module Width) = 18mm ¹⁾ 1P+N variant

** Purchase MOQ for our authorized dealers is in multiples of standard packing, contact Siemens Sales Office for further details

§ For connecting accessories with 2P 2M RCBO add handle connector 5ST38051

Betagard Accessories

Accessories for 5SL / 5SY / 5SP MCBs, 5TL Isolators, 5SV RCCBs, 5SM2 RC Units and 5SU1 RCBOs

	Item Description	Reference No	Unit MRP* ₹	Std. Pkg.** (Nos.)	
	Aux contact block (For 5SL/5SY/5SP4/5TL/5SV/5SU1/5SM2)				
	1NO+1NC	5ST3010 ¹⁾	2000.-	12	
	2NO	5ST3011 ¹⁾	2045.-	1	
	2NC	5ST3012 ¹⁾	2045.-	1	
	1CO	5ST3016 ¹⁾	3240.-	1	
	Fault signal contact (For 5SL/5SY/5SP4/5SV/5SU1/5SM2)				
	1NO+1NC	5ST3020 ¹⁾	2945.-	1	
	2NO	5ST3021 ¹⁾	2990.-	1	
	2NC	5ST3022 ¹⁾	2990.-	1	
	Shunt release (For 5SL5/5SL7/5SY/5SP4/5SV/5SU1/5SM2)				
110...415V AC	5ST3030 ¹⁾	8255.-	1/5		
24...48V DC	5ST3031 ¹⁾	8255.-	1/5		
Auxiliary and fault signal changeover contact (5SL/5SY/5SP4/5TL/5SV/5SU1/5SM2)					
Auxiliary switch - 1CO Fault contact - 1CO	5ST3062	9525.-	1		
	Undervoltage release (For 5SL5/5SL7/5SY/5SP4/5SV/5SU1/5SM2)				
	With integrated aux. switch				
	230V AC	5ST3040 ¹⁾	11085.-	1/5	
	110V DC	5ST3041 ¹⁾	11085.-	1/5	
	24V DC	5ST3042 ¹⁾	11085.-	1/5	
	Without integrated aux. switch				
	230V AC	5ST3043 ¹⁾	11085.-	1/5	
	110V DC	5ST3044 ¹⁾	11085.-	1/5	
	24V DC	5ST3045 ¹⁾	11085.-	1/5	
		Remote control mechanism unit			
Basic version for 5SL, 5SY, 5TL1 and 5SU1 (1P+N only) (12-30)V AC & (12-48)V DC, 1.5MW 230V AC, 2MW		5ST3053 5ST3054	49450.- 49450.-	1 1	
Power version for 5SL, 5SY, 5TL1, 5SU1 & 5SM2 (12-30)V AC & (12-48)V DC, 2MW 230V AC, 2MW		5ST3055 5ST3056	83685.- 83685.-	1 1	
Power version for 5SM2 (12-30)V AC & (12-48)V DC, 2MW		5ST3070	97645.-	1	
Auto Reclose Device Version for 5SM2 (12-30)V AC & (12-48)V DC, 2MW 230V AC, 2MW		5ST3057 5ST3058	80140.- 93940.-	1 1	
Adapter for Remote control mechanism (To be ordered along with 5ST305X basic unit)					
For 5SL - 1P & 2P, 5SV - 4P and 5SM2- 2P		5ST38206	1045.-	1	
For 5SL - 3P & 4P and 5SM2 - 3P & 4P		5ST38207	1045.-	1	
For 5SY - 1P & 2P and For 5SU1 [^] - 2P, 4M		5ST38201	1045.-	1	
For 5SY - 3P & 4P and For 5SU1 [^] - 4P, 7M		5ST38202	1045.-	1	
For 5SU1 - 2P, 2M		5ST38205	1045.-	1	
[^] Add-on block for 5SU1 & 5SM2 to be ordered along with Adapter		5ST38203	2275.-	1	
		Handle locking device			
		for 5SP and 5SY circuit breakers for padlock with max. 3mm shackle	5ST3801	1030.-	1
		for 5SL circuit breakers, 5TL1 isolators and 5SV residual current circuit breakers for padlock with max. 3 to 6 mm shackle	5ST3806	975.-	5
	Pad locks for 5ST3801 and 5ST3806 handle locking devices	5ST3802	660.-	5	
	Handle connector for 2P, 2M 5SU1 RCBO ⁵ (1set = 5 units in poly bag)	5ST38051	2050.-	1	

Betagard Rotary Handle Assembly

	Item Description	Reference No.	Unit MRP* ₹	Std. Pkg.** (Nos.)
	Rotary Handle Assembly for 5SY, 5SL, 5SP and 5TL1 series of MCBs/ Isolators ⁵⁵	5ST38140RC	3680.-	1

Note: * MRP - Maximum Retail Price # 1MW (Module Width) = 18mm

\$ For 2P, 2M RCBOs, the accessories can be used along with Handle connector only

\$\$ Not suitable for 1P variants 1) Suffix -Z191 will be added for internal ordering

** Purchase MOQ for our authorized dealers is in multiples of standard packing, contact Siemens Sales Office for further details

Sinova Opulenz

Multitasking switches for multitasking homes.

Elegant
finishes to enhance the look of your home.



Premium colours and textures
to complement modern finishes on your walls.



Antibacterial switches
for a safe home.



ISI certified
for assured safety.



Environment friendly
RoHS compliant switches.



Comprehensive communication range
type tested as per standards ensuring higher reliability.



Scan/Click
to know
more!

When homes and offices multitask as online classrooms, home offices, private theaters and more, the Opulenz range multitasks to help you make the most of them. Sinova Opulenz is a complete range of new age sockets, HDMI receptors, LAN ports, regulators and dimmers in seven exciting colours and two natural textures.



SIEMENS



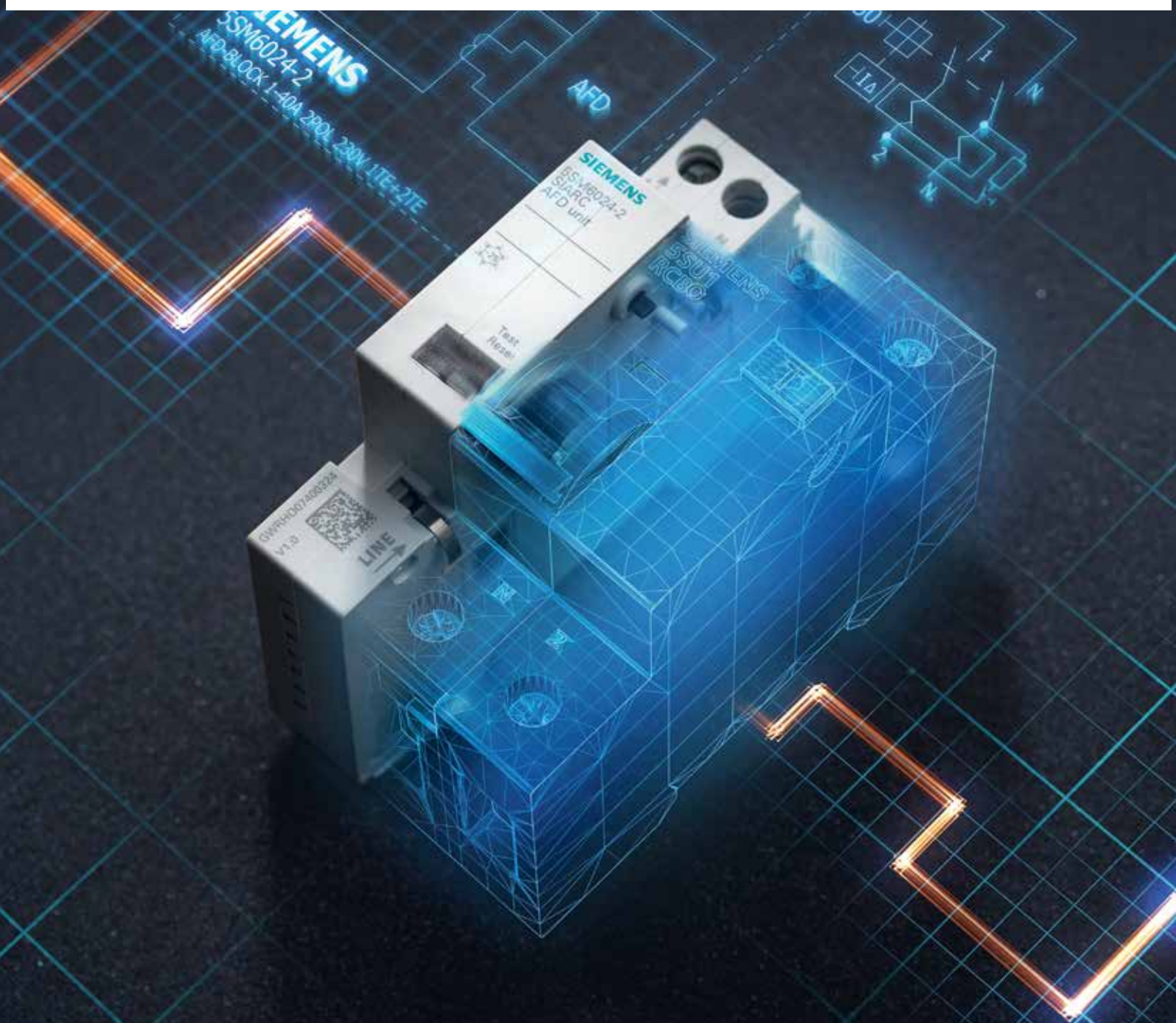

Arc Fault Detection Device

It's Time to Act Now!

With the 5SV6 Arc Fault Detection Device (AFDD), Siemens presents the third generation of fire-prevention product. The 5SV6 Arc Fault Detection Device with integrated miniature circuit breaker (MCB) is the first device on the IEC market with just one module width and is the smallest of its kind worldwide.

A standard-compliant expansion of the electrical installation by protection against electrical fires is thus always possible – easily and without the need for additional space.

www.siemens.com

SIEMENS



The smart solution.

Whether in an existing plant or a new installation – the 5SV6 AFDD and 5SM6 AFD unit can be deployed in any distribution board. It quickly identifies dangerous faults caused by parallel or serial arcing faults and switches off before a fire occurs. The AFDD detects operational arcing faults and only trips in the event of an actual fault.

5SV6 AFDDs with Integrated MCB & RCBO in 18mm width

	Rating	With integrated MCB				With integrated RCBO		Std. Pkg.** (Nos.)
		B characteristic	Unit LP* ₹	C characteristic	Unit LP* ₹	30mA, Type A, C characteristic	Unit LP* ₹	
	6A	5SV60166KK06	46040.-	5SV60167KK06	46040.-	5SV63167KK06	53720.-	1
	10A	5SV60166KK10	46040.-	5SV60167KK10	46040.-	5SV63167KK10	53720.-	
	13A	5SV60166KK13	47260.-	5SV60167KK13	47260.-	5SV63167KK13	53720.-	
	16A	5SV60166KK16	46040.-	5SV60167KK16	46040.-	5SV63167KK16	53720.-	
	20A	5SV60166KK20	52175.-	5SV60167KK20	52175.-	5SV63167KK20	59230.-	
	25A	5SV60166KK25	52175.-	5SV60167KK25	52175.-	5SV63167KK25	59230.-	
	32A	5SV60166KK32	52175.-	5SV60167KK32	52175.-	5SV63167KK32	59230.-	
	40A	5SV60166KK40	53720.-	5SV60167KK40	53720.-	5SV63167KK40	59230.-	

5SM6 AFDD with integrated MCB

	Rating	Module width	Reference No.	Description	Unit LP* ₹	Std. Pkg.** (Nos.)
	16A	2	5SM60111XX02	AFDD 16A, 230V, 2MW (Integrated with 1MW, 1+N, 16A MCB)	71170.-	1

5SM6 AFD units (Suitable for add on with RCBO)

	Rating	Module width	Reference No.	Description	Unit LP* ₹	Std. Pkg.** (Nos.)
	16A	3	5SM60212	AFD Unit 1-16A, 230V, 1MW (Suitable for 2P 2M, 5SU1 RCBO)	39960.-	1
	40A	3	5SM60242	AFD Unit 1-40A, 230V, 1MW (Suitable for 2P 2M, 5SU1 RCBO)	56445.-	

* LP - List Price

** Purchase MOQ for our authorized dealers is in multiples of standard packing, contact Siemens Sales Office for further details

SIEMENS

SENTRON Circuit protection devices with measuring and communication function



**SENTRON
5SV6 COM
AFDD/MCB**



**SENTRON
Powercenter 1000
data transceiver**



SENTRON AFDD COM 5SV6

	Rating	With integrated MCB				Std. Pkg.** (Nos.)
		B characteristic	Unit LP* ₹	C characteristic	Unit LP* ₹	
	6 A	5SV60166MC06	Price on request	5SV60167MC06	Price on request	1
	10 A	5SV60166MC10		5SV60167MC10		
	13 A	5SV60166MC13		5SV60167MC13		
	16 A	5SV60166MC16		5SV60167MC16		
	20 A	5SV60166MC20		5SV60167MC20		
	25 A	5SV60166MC25		5SV60167MC25		
	32 A	5SV60166MC32		5SV60167MC32		

SENTRON Powercenter 1000 7KN

	Reference No.	Description	Unit LP* ₹	Std. Pkg.** (Nos.)
	7KN11100MC00	Powercenter1000 max. 24 SENTRON COM devices Modbus TCP Bluetooth Power supply DC 24V	Price on request	1

* LP - List Price

** Purchase MOQ for our authorized dealers is in multiples of standard packing, contact Siemens Sales Office for further details

Applications:



Operating hours counter

The values measured by the installation device provide information on the electrical consumer's (e.g., an LED) exact operating time allowing for optimized maintenance.



Fault monitoring

A decline of electrical current, voltage or temperature below normal values may hint at a failure of the electrical consumer. An increased electrical current may indicate a defect of connected equipment.



Load management

When a certain number of electrical consumers is active, additional devices cannot be switched on. This prevents current peaks.



Function monitoring

The measured values indicate the execution of an activity by the electrical consumer (e.g., automatic feeders in livestock farming).

5TR4 Automatic Changeover Current Limiter

Effortlessly manage power transitions with our 5TR4 ACCL, ensuring seamless operations and preventing electrical overload.



Heavy Duty
Conforms to utilization
category AC32A
(IEC 60947-6-1)



High Endurance Cycle
Ensuring efficient and
long life of your ACCL



**Safe during Short
circuits**
Iq short circuit of 5kA



Warning & Alerts
Overload indication via
LED & Beep



Standard compliant
Product conforms to
IEC 60947-6-1



Low Power consumption
Coil operates only
during backup supply



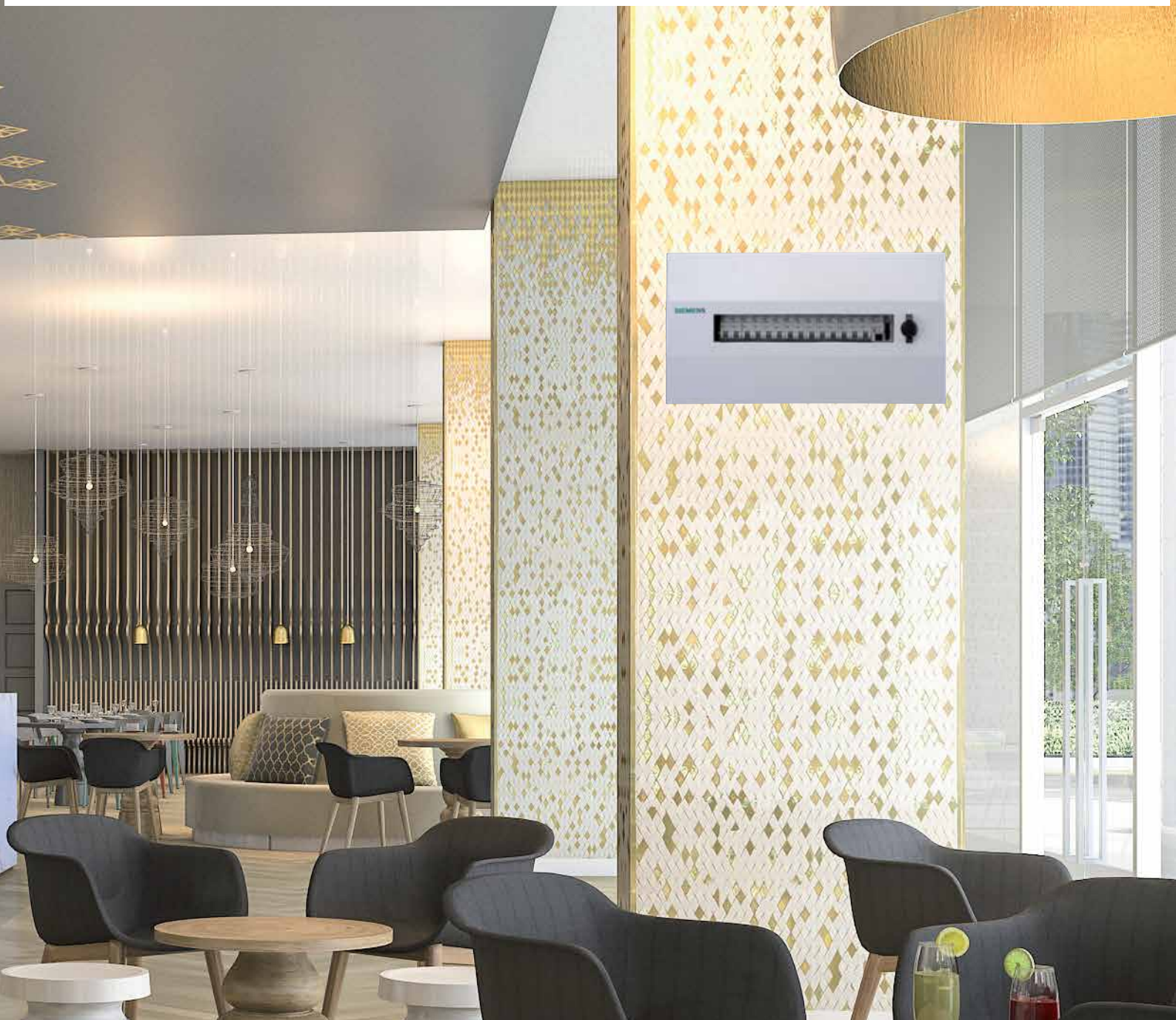

Betagard 8GB Distribution Boards

Perfect blend of beauty and features with assured performance







- Complete range for Residential, Commercial and Industrial Infrastructures
- DBs offer latest design with highest aesthetic appeal
- DBs available with type testing as per the latest applicable standards
- User friendly design offers ease during maintenance and assists the installer for correct installation

www.siemens.co.in

SIEMENS

Betagard Distribution Boards 8GB32 # SPN and TPN DBs

- Type Tested as per IEC 61439 Standards at third party and internal test laboratories
- Available in IP 20 and IP 43 Versions
- Single Door, Metal Double Door and Acrylic Double Door options available
- Standard Wire Way Boxes available for all Single Door and Double Door DBs
- Additional safety with Insulated Shorting Links, Shrouded Neutral Links and Door Earthing
- TPN DBs can be easily made suitable for PPI configuration using TPN to PPI Conversion Kits
- Detachable DIN rail assembly and intermittent door facilitates ease in Wiring during installation and maintenance
- DBs are subjected to Seven tank process and treated with premium quality powder coating
- Cement Masking Sheet protects the DBs against extreme site conditions







	Item Description	Incoming Slots (MW)	Outgoing Slots (MW)	Total Slots (MW)	Reference No	Unit MRP* ₹	Std. Pkg.** (Nos.)
Metal Enclosures, IP20:							
	1 Module	–	–	1	8GB32100RC01	1140.-	1/20
	2 Module	–	–	2	8GB32100RC02	1700.-	1/20
	3 Module	–	–	3	8GB32100RC03	1700.-	1/20
	4 Module	–	–	4	8GB32100RC04	1700.-	1/20
	6 Module	–	–	6	8GB32100RC06	2240.-	1/20
	8 Module	–	–	8	8GB32100RC08	2640.-	1/10
SPN Single Door DBs#, IP20:							
	6 Module	2	4	6	8GB32101RC06	3355.-	1
	8 Module	2	6	8	8GB32101RC08	3565.-	1
	10 Module	2	8	10	8GB32101RC10	4290.-	1
	12 Module	2	10	12	8GB32101RC12	4445.-	1
	14 Module	2	12	14	8GB32101RC14	5020.-	1
	16 Module	2	14	16	8GB32101RC16	5410.-	1
SPN Metal Double Door DBs#, IP 43:							
	6 Module	2	4	6	8GB32102RC06	5240.-	1
	8 Module	2	6	8	8GB32102RC08	5440.-	1
	10 Module	2	8	10	8GB32102RC10	6330.-	1
	12 Module	2	10	12	8GB32102RC12	6500.-	1
	14 Module	2	12	14	8GB32102RC14	7580.-	1
	16 Module	2	14	16	8GB32102RC16	7765.-	1
SPN Acrylic Double Door DBs#, IP 43:							
	6 Module	2	4	6	8GB32103RC06	6155.-	1
	8 Module	2	6	8	8GB32103RC08	6500.-	1
	10 Module	2	8	10	8GB32103RC10	7580.-	1
	12 Module	2	10	12	8GB32103RC12	8135.-	1
	14 Module	2	12	14	8GB32103RC14	8485.-	1
	16 Module	2	14	16	8GB32103RC16	8850.-	1
Wire Way Box For SPN Single Door IP 20 DBs:							
	For 6 MOD SPN Single door DB	–	–	–	8GB32106RC06	2210.-	1/5
	For 8 MOD SPN Single door DB	–	–	–	8GB32106RC08	2210.-	1/5
	For 10 MOD SPN Single door DB	–	–	–	8GB32106RC10	2380.-	1/5
	For 12 MOD SPN Single door DB	–	–	–	8GB32106RC12	2380.-	1/5
	For 14 MOD SPN Single door DB	–	–	–	8GB32106RC14	2745.-	1/5
	For 16 MOD SPN Single door DB	–	–	–	8GB32106RC16	2745.-	1/5
Wire Way Box For SPN Double Door IP 43 DBs:							
	For 6 MOD SPN Double door DB	–	–	–	8GB32107RC06	2380.-	1/5
	For 8 MOD SPN Double door DB	–	–	–	8GB32107RC08	2380.-	1/5
	For 10 MOD SPN Double door DB	–	–	–	8GB32107RC10	2585.-	1/5
	For 12 MOD SPN Double door DB	–	–	–	8GB32107RC12	2585.-	1/5
	For 14 MOD SPN Double door DB	–	–	–	8GB32107RC14	3285.-	1/5
	For 16 MOD SPN Double door DB	–	–	–	8GB32107RC16	3285.-	1/5

Note: * MRP - Maximum Retail Price # Also available in flat door option

For Customized Solutions in Distribution Boards please Contact our sales Office

** Purchase MOQ for our authorized dealers is in multiples of standard packing, contact Siemens Sales Office for further details

Betagard Distribution Boards 8GB32 # SPN and TPN DBs

	Item Description	Incoming Slots (MW)	Outgoing Slots (MW)	Total Slots (MW)	Reference No	Unit MRP* ₹	Std. Pkg.** (Nos.)
TPN Single Door DBs#, IP20:							
	4 way	8	12	20	8GB32201RC04	8675.-	1
	6 way	8	18	26	8GB32201RC06	9850.-	1
	8 way	8	24	32	8GB32201RC08	11885.-	1
	10 way	8	30	38	8GB32201RC10	17245.-	1
	12 way	8	36	44	8GB32201RC12	17610.-	1
	14 way	8	42	50	8GB32201RC14	20195.-	1
	16 way	8	48	56	8GB32201RC16	20950.-	1
TPN Metal Double Door DBs#, IP 43							
	4 way	8	12	20	8GB32202RC04	10595.-	1
	6 way	8	18	26	8GB32202RC06	12805.-	1
	8 way	8	24	32	8GB32202RC08	15390.-	1
	10 way	8	30	38	8GB32202RC10	22230.-	1
	12 way	8	36	44	8GB32202RC12	22785.-	1
	14 way	8	42	50	8GB32202RC14	27045.-	1
	16 way	8	48	56	8GB32202RC16	27815.-	1
TPN Acrylic Double Door DBs#, IP 43							
	4 way	8	12	20	8GB32203RC04	12805.-	1
	6 way	8	18	26	8GB32203RC06	15765.-	1
	8 way	8	24	32	8GB32203RC08	18910.-	1
	10 way	8	30	38	8GB32203RC10	24660.-	1
	12 way	8	36	44	8GB32203RC12	28705.-	1
	14 way	8	42	50	8GB32203RC14	30745.-	1
	16 way	8	48	56	8GB32203RC16	32815.-	1
TPN to PPI Conversion Kit®							
	To convert 6 way TPN DB to 4 way TPN PPI DB				8GB32205RC04	6685.-	1/5
	To convert 8 way TPN DB to 6 way TPN PPI DB				8GB32205RC06	7795.-	1/5
	To convert 10 way TPN DB to 8 way TPN PPI DB				8GB32205RC08	7990.-	1/5
	To convert 12 way TPN DB to 10 way TPN PPI DB				8GB32205RC10	8530.-	1/5
	To convert 14 way TPN DB to 12 way TPN PPI DB				8GB32205RC12	9110.-	1/5
	To convert 16 way TPN DB to 14 way TPN PPI DB				8GB32205RC14	9635.-	1/5
Wire Way Box For TPN Single Door IP 20 DBs							
	For 4 Way TPN Single door DB	-	-	-	8GB32206RC04	2820.-	1/5
	For 6 Way TPN Single door DB	-	-	-	8GB32206RC06	2820.-	1/5
	For 8 Way TPN Single door DB	-	-	-	8GB32206RC08	5040.-	1/5
	For 10 Way TPN Single door DB	-	-	-	8GB32206RC10	6330.-	1/5
	For 12 Way TPN Single door DB	-	-	-	8GB32206RC12	6510.-	1/5
	For 14 Way TPN Single door DB	-	-	-	8GB32206RC14	6685.-	1/5
	For 16 Way TPN Single door DB	-	-	-	8GB32206RC16	7080.-	1/5
Wire Way Box For TPN Double Door IP 43 DBs							
	For 4 Way TPN Double door DB	-	-	-	8GB32207RC04	2990.-	1/5
	For 6 Way TPN Double door DB	-	-	-	8GB32207RC06	3385.-	1/5
	For 8 Way TPN Double door DB	-	-	-	8GB32207RC08	5390.-	1/5
	For 10 Way TPN Double door DB	-	-	-	8GB32207RC10	5775.-	1/5
	For 12 Way TPN Double door DB	-	-	-	8GB32207RC12	7080.-	1/5
	For 14 Way TPN Double door DB	-	-	-	8GB32207RC14	7435.-	1/5
	For 16 Way TPN Double door DB	-	-	-	8GB32207RC16	7645.-	1/5

Note: * MRP - Maximum Retail Price

@ Contains required accessories to Make the DB suitable for PPI Configuration

For Customized Solutions in Distribution Boards please Contact our sales Office

** Purchase MOQ for our authorized dealers is in multiples of standard packing, contact Siemens Sales Office for further details

Also available in flat door option

Betagard Distribution Boards 8GB32 TPN Phase Segregated DBs

Item Description	Incoming Slots (MW)	Sub-Incomer Slots (MW)	Outgoing Slots (MW)	Total Slots (MW)	Reference No	Unit MRP* ₹	Std. Pkg.** (Nos.)
TPN Phase segregated DBs, IP 20 For MCB as incomer							
4 Way	12	12	12	36	8GB32001RC04	23220.-	1
6 Way	12	12	18	42	8GB32001RC06	26115.-	1
8 Way	12	12	24	48	8GB32001RC08	30485.-	1
12 Way	12	12	36	60	8GB32001RC12	36295.-	1
TPN Phase segregated DBs, (8 segment) IP 43 For MCB as incomer							
4 way	12	12	12	36	8GB32002RC04	27575.-	1
6 way	12	12	18	42	8GB32002RC06	31935.-	1
8 way	12	12	24	48	8GB32002RC08	36295.-	1
12 way	12	12	36	60	8GB32002RC12	43540.-	1
TPN Phase segregated DBs, IP 43 for MCCB as incomer upto 160A							
6 way		12	18	30	8GB32012RC06	49325.-	1
8 way		12	24	36	8GB32012RC08	56595.-	1
12 way		12	36	48	8GB32012RC12	63855.-	1
Wire Way box for MCB Incomer, IP 43 DBs							
For 4 Way	-	-	-	-	8GB32007RC04	7245.-	1
For 6 Way	-	-	-	-	8GB32007RC06	8695.-	1
For 8 Way	-	-	-	-	8GB32007RC08	10140.-	1
For 12 Way	-	-	-	-	8GB32007RC12	11595.-	1
Wire Way box for MCCB Incomer, IP 43 DBs							
For 6 Way	-	-	-	-	8GB32017RC06	8695.-	1
For 8 Way	-	-	-	-	8GB32017RC08	10140.-	1
For 12 Way	-	-	-	-	8GB32017RC12	11595.-	1

Betagard Distribution Board 8GB

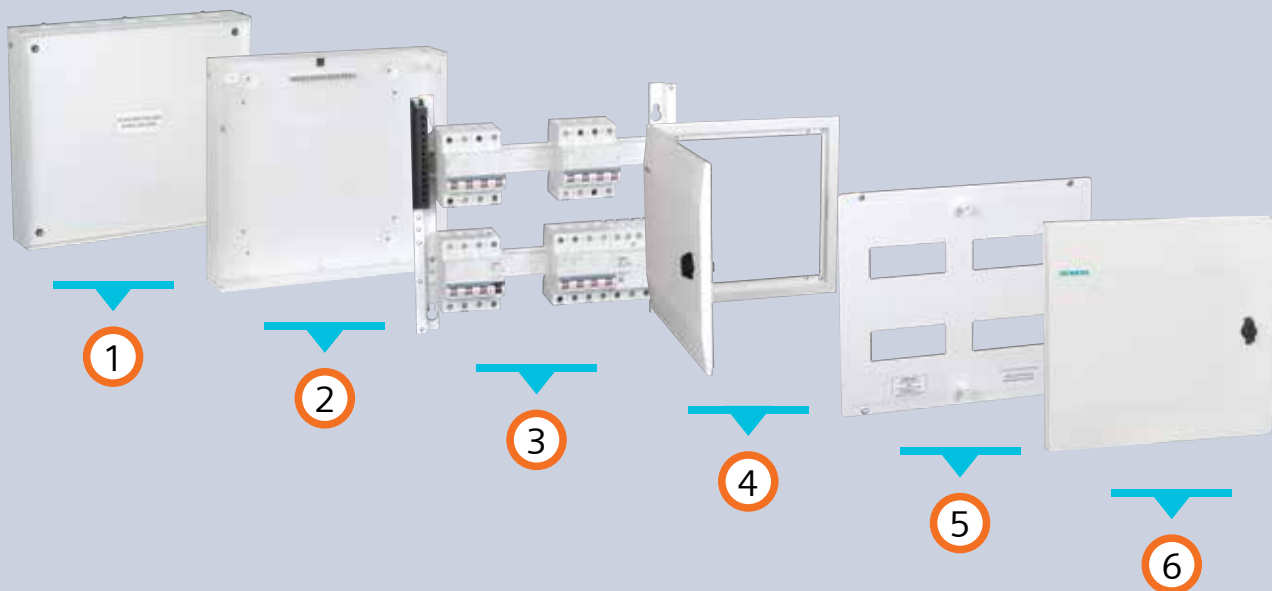

1 U-box with Cement Masking sheet
2 U-box with Earth links

3 Detachable Din-rail channel with Shrouded Neutral link
4 Door frame with Door

5 Detachable Intermittent Plate
6 Door with Quarter Turn Knob

Note: * MRP - Maximum Retail Price

** Purchase MOQ for our authorized dealers is in multiples of standard packing, contact Siemens Sales Office for further details

Industrial plug & sockets

	Item Description	Total Slots (MW)	Reference No	Unit MRP* ₹	Std. Pkg.** (Nos.)
Plug & Socket, IP20 with provision for MCB mounting :					
	1 Phase 20A, 1P MCB	1	8GB0501RC	3770.-	1/20
	1 Phase 20A, 2P MCB	2	8GB0501SRC	3770.-	1/20
	3 Phase 32A, 3P MCB	3	8GB0502	7975.-	1/15
	3 Phase 32A, 3P+N MCB	4	8GB0502S	7975.-	1/15
	5 Pin (3P+N+PE) 3Phase 32A MCB 3P+N MCB	8	8GB050332	12600.-	1/5
	5 Pin (3P+N+PE) 3Phase 63A MCB 3P+N MCB	8	8GB050363	32825.-	1/5

Simbox WP

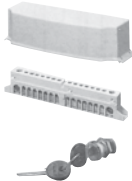
	Item Description	Total Slots (MW)	Reference No	Unit MRP* ₹	Std. Pkg.** (Nos.)
Simbox WP (IP65 DBs)					
	1 Row, 4Mod	4	8GB13710	Price on request	1
	1 Row 8Mod	8	8GB13711		1
	1 Row 12Mod	12	8GB13712		1
	1 Row 18Mod	18	8GB13713		1
	2 Row 2 x 12Mod	24	8GB13722		1
	2 Row, 2 x 18Mod	36	8GB13723		1
	3 Row, 3 x 18Mod	54	8GB13733		1
	4 Row 4 x 18Mod	72	8GB13743		1
Accessories for Simbox WP					
	Coupling covers,12M		8GB20510	Price on request	1
	Coupling covers,18M		8GB20511		1
	Insulated N/PE terminals, 8MW		8GB20520		1
	Insulated N/PE terminals, 12MW		8GB20521		1
	Insulated N/PE terminals, 18MW		8GB20522		1
	Cylindrical security lock		8GB20550		1









Note: * MRP - Maximum Retail Price

For Customized Solutions in Distribution Boards please Contact our sales Office

** Purchase MOQ for our authorized dealers is in multiples of standard packing, contact Siemens Sales Office for further details



Betagard Distribution Boards Accessories

	Item Description	Reference No	Unit MRP* ₹	Std. Pkg.** (Nos.)
Blanking Plate				
	1 MW	8GB9901	145.-	25
Insulated Shorting Links				
Single Phase Shorting Links for Shorting 1P MCBs				
For SPN and TPN PPI DB				
	5 Leg SP Shorting Link	8GB9905LSP	440.-	10
	7 Leg SP Shorting Link	8GB9907LSP	515.-	10
	9 Leg SP Shorting Link	8GB9909LSP	605.-	10
	11 Leg SP Shorting Link	8GB9911LSP	640.-	10
	13 Leg SP Shorting Link	8GB9913LSP	860.-	10
	15 Leg SP Shorting Link	8GB9915LSP	1035.-	10
	17 Leg SP Shorting Link	8GB9917LSP	1090.-	10
For TPN DB				
	4 Leg SP Shorting Link	8GB9904LSP	440.-	10
	6 Leg SP Shorting Link	8GB9906LSP	515.-	10
	8 Leg SP Shorting Link	8GB9908LSP	605.-	10
	10 Leg SP Shorting Link	8GB9910LSP	640.-	10
	12 Leg SP Shorting Link	8GB9912LSP	860.-	10
	14 Leg SP Shorting Link	8GB9914LSP	1035.-	10
	16 Leg SP Shorting Link	8GB9916LSP	1090.-	10
Two Phase, 1 meter long for shorting 2P MCBs (suitable for maximum of 28 nos. 2MW devices)				
	Shorting link without End caps, Can be cut and used.	8GB990SLLDP	10740.-	1
	End Caps for 2 pole Shorting Links	8GB990ECLDP	175.-	10
Three Phase, 1 meter long for shorting 3P MCBs (suitable for maximum of 19 nos. 3MW devices)				
	Shorting link without Enc caps, Can be cut and used.	8GB990SLLTP	11750.-	1
	End Caps for 3 pole Shorting Links	8GB990ECLTP	265.-	10
Three Phase + N, 1 meter long for shorting TPN MCBs (suitable for maximum of 14 nos. 4MW devices)				
	Shorting link without Enc caps, Can be cut and used.	8GB990SLLTPN	12420.-	1
	End Caps for 3 pole Shorting Links	8GB990ECLTPN	330.-	10
Neutral Terminals				
Neutral Terminals For 8GB0 and 8GB31 DBs (Along with Mounting Stands)				
	5 Way Neutral Link	8GB9905NL	475.-	10
	11 Way Neutral Link	8GB9911NL	700.-	10
	13 Way Neutral Link	8GB9913NL	800.-	10
	15 Way Neutral Link	8GB9915NL	895.-	10
Neutral Terminals For 8GB32 DBs (With Terminal Shroud and Cover)				
	Neutral Terminal 5 Holes	8GB9905NPE	515.-	10
	Neutral Terminal 11 Holes	8GB9911NPE	715.-	10
	Neutral Terminal 13 Holes	8GB9913NPE	860.-	10
	Neutral Terminal 15 Holes	8GB9915NPE	945.-	10
Earth Terminals				
	5 Way Earth Link	8GB9905EL	395.-	10
	11 Way Earth Link	8GB9911EL	670.-	10
	13 Way Earth Link	8GB9913EL	715.-	10
	15 Way Earth Link	8GB9915EL	860.-	10

Note: * MRP - Maximum Retail Price

** Purchase MOQ for our authorized dealers is in multiples of standard packing, contact Siemens Sales Office for further details

DISCOVER THE POWER OF **SIMPLICITY**

SINOPLUS low-voltage electrical products



Cost-effective
Best price
performance
ratio



Comprehensive
range
For various
applications



Reliable
Siemens trusted
quality

IEC

Safe
Complies with
IEC standards



www.siemens.co.in

Learn more about our low-voltage electrical products or contact us for a personalized consultation and take the first step towards an efficient power future.



SIEMENS



5SD Surge Protection Devices

Safe & Reliable

Surge Protection Devices are available in the following types:

Type 1 - For incoming power supply panels, in buildings with lightning protection system. Must be accompanied by downstream SPD

Type 2 - For distribution panels located downstream of Type 1 protectors or in incoming supply panels in areas of low exposure to lightning strikes, where the building is not fitted with lightning protection system

Type 3 - Always installed downstream of Type 2 protection designed to protect sensitive equipment or equipment located more than 20m downstream of Type 2 SPD

Surge Protection Devices

For protection of equipment against Lightning and Switching surges

- Standard: IEC 61643-11 / EN 61643-11
- Type 1, Type 2 and Photovoltaic surge protection
- With Remote signaling contact
- Integrated SPD health indicator

Type 1: Lightning Surge Arresters

- Maximum continuous operating voltage U_c : 350V



Reference No.	Rated voltage	Pole	Module width	Total I_{imp} (10/350 μ s)	I_{max} (8/20 μ s)	Remote status	Unit LP* ₹
5SD74121RC	240V AC	1P+N	4	50kA	50kA	Yes	30210.-
5SD74141RC	240/415V AC	3P+N	8	100kA	50kA	Yes	58805.-

Type 2: Surge Arresters



Reference No.	Rated voltage	Pole	Module width	U_c	I_{max} (8/20 μ s)	Remote status	Unit LP* ₹
5SD74610RC	240V AC	1P	1	335V AC	20kA	No	4940.-
5SD74640RC	240/415V AC	3P+N	4	335V AC	40kA	No	14685.-

Surge Arresters for Photovoltaic application

On the DC side, over voltage protection is required for the inverters which can be ensured by using 5SD74836RC.

On the AC side, the over voltage protection can be ensured using surge arresters Type 2 (5SD7461-0RC/5SD7464-0RC)



Reference No.	Rated voltage	Pole	Module width	U_{cpv}	I_{max} (8/20 μ s)	Remote status	Unit LP* ₹
5SD74836RC	1170V DC	L+ and L-	3	1170V DC	40kA	No	8345.-

Note: Standard packing: 1 unit

*LP: List Price



Surge Protection Devices

For protection of equipment against Lightning and Switching surges

Type 1: Lightning Surge Arresters

For TN-S/ TT system

Lightning arresters, Type 1 requirement class B, U_c 350V Pluggable protective modules 4-pole, 3+1 circuit for TN-S and TT systems with remote display



5SD74121



5SD74141

Rated voltage U_N	Backup fuse rating	Protection level	Lightening impulse current $I_{mp}(10/350\mu s)$		Pole	Reference No.	Unit LP* ₹
			L-N or L-(PE), 1P/3P	N-PE			
240V AC	125A gL/gG	1.5-2.5kV	25kA	100kA	1P+N	5SD74121	108770.-
240/415V AC	125A gL/gG	1.5-2.5kV	25kA/75kA	100kA	3P+N	5SD74141	184510.-

For TN-C system

Lightning arresters, Type 1 requirement class B, U_c 350V Pluggable protective modules 3-pole, 3+0 circuit for TNC systems with remote display



5SD74131

Rated voltage U_N	Backup fuse rating	Protection level	Lightening impulse current $I_{mp}(10/350\mu s)$		Pole	Reference No.	Unit LP* ₹
			L-N or L-(PE), 1P/3P	N-PE			
240/415V AC	125A gL/gG	$\leq 1.5kV$	25kA/75kA	-	3P	5SD74131	144335.-

Type 2 : Surge Arresters

For TN-S/ TT system

Surge arrester Type 2 requirement class C, U_c :350V/260V (L-N/N-PE) Pluggable protective modules 4-pole, 3+1 circuit for TN-S and TT AC systems

Rated Discharge Surge Current $I_n=20kA$

SC capacity with backup fuse=25kA



5SD74641



5SD7422-0

Rated voltage U_N	Backup fuse rating	Protection level U_p	Rated discharge current I_n (8/20usec)		Pole	Remote signaling	Reference No.	Unit LP* ₹
			L-N or L-(PE), 1P/3P	N-PE				
240/415V	80A gL/gG	1.5-1.9kV	40kA	40kA	3P+N	No	5SD74640	57185.-
240/415V	80A gL/gG	1.5-1.9kV	40kA	40kA	3P+N	Yes	5SD74641	42190.-
240V	80A gL/gG	1.5-1.9kV	20kA	20kA	1P+N	No	5SD74220	33155.-
240V	80A gL/gG	1.5-1.9kV	20kA	20kA	1P+N	Yes	5SD74221	36605.-

For TN-C system

Surge arrester Type 2 requirement class C, U_c :350V Pluggable protective modules 3-pole, 3+0 circuit for TNC systems



5SD7463-0

Rated voltage U_N	Backup fuse rating	Protection level U_p	Maximum discharge surge current I_{max} L-N or L-(PE)N, 1P		Pole	Remote signaling	Reference No.	Unit LP* ₹
			L-N or L-(PE)N, 1P	L-N or L-(PE)N, 1P				
240/415V	80A gL/gG	$\leq 1.5kV$	40kA	40kA	3P	No	5SD74630	48905.-
240/415V	80A gL/gG	$\leq 1.5kV$	40kA	40kA	3P	Yes	5SD74631	51145.-

L - Line, N - Neutral, PE - Protective Earth

Note: Standard packing: 1 unit

* LP : List Price

Surge Protection Devices

For protection of equipment against Lightning and Switching surges

Type 3 : Surge Arresters

	Rated voltage	Rated current	Protection level	Rated discharge current	Pole	Reference No.	Unit LP* ₹
	24V AC 34V DC	26A	0.65kV	1kA	2P	5SD74325	23185.-
	120V AC 150V DC	26A	0.95kV	3kA	2P	5SD74326	25260.-
	240V AC 240V DC	26A	1.5kV	3kA	2P	5SD74327	25940.-

Surge arresters for photovoltaic application

Due to the combination of three power varistors, the overvoltage protection required for the inverters is implemented on the DC side. On the AC side, the overvoltage protection can be ensured using surge arresters type 2 (5SD7422-/5SD7424-)

	Rated voltage U _N	Rated discharge current	Protection level U _p	Lightning Impulse current (L-N/L-(PE)N)	Max. discharge current	Pole	Remote signaling	Reference No.	Unit LP* ₹
 5SD74836	1000V DC	15kA	≤3.5kV	≤5kA	40kA	3P	No	5SD74836	8345.-

Replacement Plug

	SPD Type	Type	Connection	Reference No.	Unit LP* ₹
	5SD74121	Type 1	L-N	5SD74181	40695.-
	5SD74131				
	5SD74141				
	5SD74121		N-PE	5SD74180	42655.-
	5SD74131				
	5SD74141				
	5SD7463-0/1	Type 2	L-N	5SD74681	11950.-
	5SD7464-0/1				
	5SD7464-0/1				
	5SD7422-0/1		N-PE	5SD74880	14990.-
	5SD7422-0/1				
	5SD7422-0/1				
5SD7422-0/1	PV	-	5SD74281	11950.-	
5SD7422-0/1					5SD74280
5SD7483-6			5SD74983	12325.-	

* Also available Type 1+ Type 2 and Type 1/2 Compact SPDs for protection against overvoltages from Lightning strikes as well as by switching operations in network

Note:
Standard packing: 1 unit
* LP - List Price





SENTRON Modular Devices

For efficient control and monitoring

- 7LF time switch - Digital and Analog timers for all applications; available in Mini, Top, Profi, Astro, Expert and Expert GPS variants
- 5TT5 insta contactors – For all control applications; also with Manual/Automatic switching indicator
- DIN mounted phase indicators, monitoring relays and measuring devices for final distribution circuits
- Twilight Switch for Automatic Street Light Control

Modular Devices

	Item Description	Rated Current I _n (A)	MW#	Reference No	Unit LP* ₹	Std. Pkg.** (Nos.)
Insta Contactors						
Standards: EN 60947-4-1, EN 60947-5-1						
	3NO+1NC contacts, 230V AC/220V DC (1NC contact rated for 30A)	40	3	5TT58410	16575.-	1/5
	3NO+1NC contacts, 24V AC/24V DC (1NC contact rated for 30A)	40	3	5TT58412	16655.-	1/5
	4NO contacts, 230V AC/220V DC	40	3	5TT58400	16705.-	1/5
	4NO contacts, 24V AC/24V DC	40	3	5TT58402	16680.-	1/5
	3NO+1NC contacts, 230V AC/220V DC (1NC contact rated for 30A)	63	3	5TT58510	25955.-	1/5
	3NO+1NC contacts, 24V AC/24V DC, (1NC contact rated for 30A)	63	3	5TT58512	26430.-	1/5
	4NO contacts, 230V AC/220V DC	63	3	5TT58500	21170.-	1/5
	4NO contacts, 24V AC/24V DC	63	3	5TT58502	21215.-	1/5
Insta Contactors Manual / Automatic with Switching Indicator						
Standards: IEC60947-4-1, IEC60947-5-1						
	4NO contacts, 400V AC	40	3	5TT58406	24540.-	1/5
	4NO contacts, 400V AC	63	3	5TT58506	32150.-	1/5
Accessories						
	Control Switch with 1 Make and 1 Break Contact For AC 230V/400V For 5TT58 and 5TT50			5TT59101	7390.-	1/10
Twilight switch						
	Twilight Switch with light sensor 230 V, 50/60 Hz, 1MW, 16A			7LQ2300	69530.-	1





Note:

* LP - List Price # 1MW (Module Width) = 18mm

** Purchase MOQ for our authorized dealers is in multiples of standard packing, contact Siemens Sales Office for further details



Modular Devices



	Item Description	Rated Current I _n (A)	MW#	Reference No	Unit LP* ₹	Std. Pkg.** (Nos.)
Voltage Relays						
Standards: IEC 60255, DIN VDE 0435-303						
	Voltage relay for undervoltage monitoring of 1,2,3 phases against N with phase failure detection, Switching thresholds 0.7-0.9xV, not adjustable; 2 C/O contacts, 4A, 230/400V AC	4	2	5TT3402	Price on request	1
	Voltage relay for undervoltage monitoring of 1,2,3 phases against N, short time failure detection with phase failure detection and N conductor monitoring, Switching thresholds 0.8-0.85xV, not adjustable; 2 C/O contacts, 230/400V AC	4	2	5TT3407	Price on request	1
	Voltage relay for over and undervoltage monitoring of 3 phases against N with asymmetry, reverse voltage and phase failure detection with N conductor monitoring and adj. Time delay of 0.1 to 20s, Switching thresholds: U/voltage 0.7-1.1xV, 4% hysteresis, adjustable, O/voltage 0.9-1.1xV, 4% hysteresis, adjustable; 2 C/O contacts, 230/400V AC	4	2	5TT3408	Price on request	1
RYG 3 phase indicator in 1MW						
	3 phase indicator (all with green color cap)		1	5TE5802	6755.-	1/10
	3 phase indicator (red/yellow/green)		1	5TE5803	6425.-	1/10
	Transparent cap (1 set = 3 items, R, Y, G lens)			5TG8070	1725.-	1/10
Power ON Indicator (Economy Version) 230 V AC, 1 Phase						
	Light indicators for max. cable length up to 5 m with 1 red lamp		1	5TE5800	4030.-	1/12
	Light indicators for max. cable length up to 250 m with 1 red lamp		1	5TE5804	5120.-	1/12
	Transparent cap (Red) (1 set 5x each red/transparent)			5TG8061	2230.-	5
	Transparent cap (Green) (1 Set with 5x each green/transparent)			5TG8062	2230.-	5
	Transparent cap (Yellow) (1 Set with 5x each yellow/transparent)			5TG8063	2230.-	5
	Transparent cap (Blue) (1 Set with 5x each blue/transparent)			5TG8064	2230.-	5
Fuse Monitor						
	Fuse monitors with transparent caps for all low voltage fuse systems, 230V AC	4	2	5TT3170	Price on request	1

Note:

* LP - List Price # 1MW (Module Width) = 18mm

** Purchase MOQ for our authorized dealers is in multiples of standard packing, contact Siemens Sales Office for further details

Modular Devices

	Item Description	Rated Current I _n (A)	MW#	Reference No	Unit LP* ₹	Std. Pkg.** (Nos.)
Time Switches (Digital)						
	Mini digital, daily/weekly program, 100 hours reserve, 230V AC	16	1	7LF45015	15680.-	1
	Yearly time switch top digital 230V, 1 channel	16	2	7LF45110	19200.-	1
	Yearly time switch top digital 230V, 2 channel	16	2	7LF45120	36760.-	1
	Weekly time switch profi digital 230V, 1 channel	16	2	7LF45210	34245.-	1
	Weekly time switch profi digital 230V, 2 channel	16	2	7LF45220	44290.-	1
	Weekly time switch astro digital 230V, 1 channel	16	2	7LF45310	34525.-	1
	Weekly time switch astro digital 230V, 2 channel	16	2	7LF45320	57715.-	1
Time Switches (Mechanical) Standards: EN 60730-1						
 7LF53005	Quartz time switch Day 1 NO 230V/50-60Hz 1 MW with power reserve	16	1	7LF53011	21245.-	1
	Synchronous time switches without power reserve, for DIN rail mounting, day disk, 1CO, 230V AC	16	3	7LF53005	11725.-	1
	Quartz-clock time switches with power reserve for DIN rail mounting, day disk, 1CO, 230V AC	16	3	7LF53016	22565.-	1
	Quartz-clock time switches with power reserve for wall mounting, day disk, 1CO, 250V AC	16	—	7LF53050	24685.-	1
	Synchronous time switches without power reserve, for wall mounting, day disk, 1CO, 250V AC	16	—	7LF53010	13915.-	1
Accessories for Digital Time Switches						
	USB adapter and software			7LF49410	56825.-	1
	Data key profi, astro			7LF49411	5785.-	1

Note:

* LP - List Price

1MW (Module Width) = 18mm

** Purchase MOQ for our authorized dealers is in multiples of standard packing, contact Siemens Sales Office for further details



3NA6 Fuse with Insulated Gripping Lugs

NEW

Enhancement in safety with high grade plastic cover plates.

IEC

Safe
Complies with
IEC standards



Ease of
Maintenance
Retrofitting at
site



Reliable
Siemens trusted
quality



RoHS
Complies to
RoHS directives



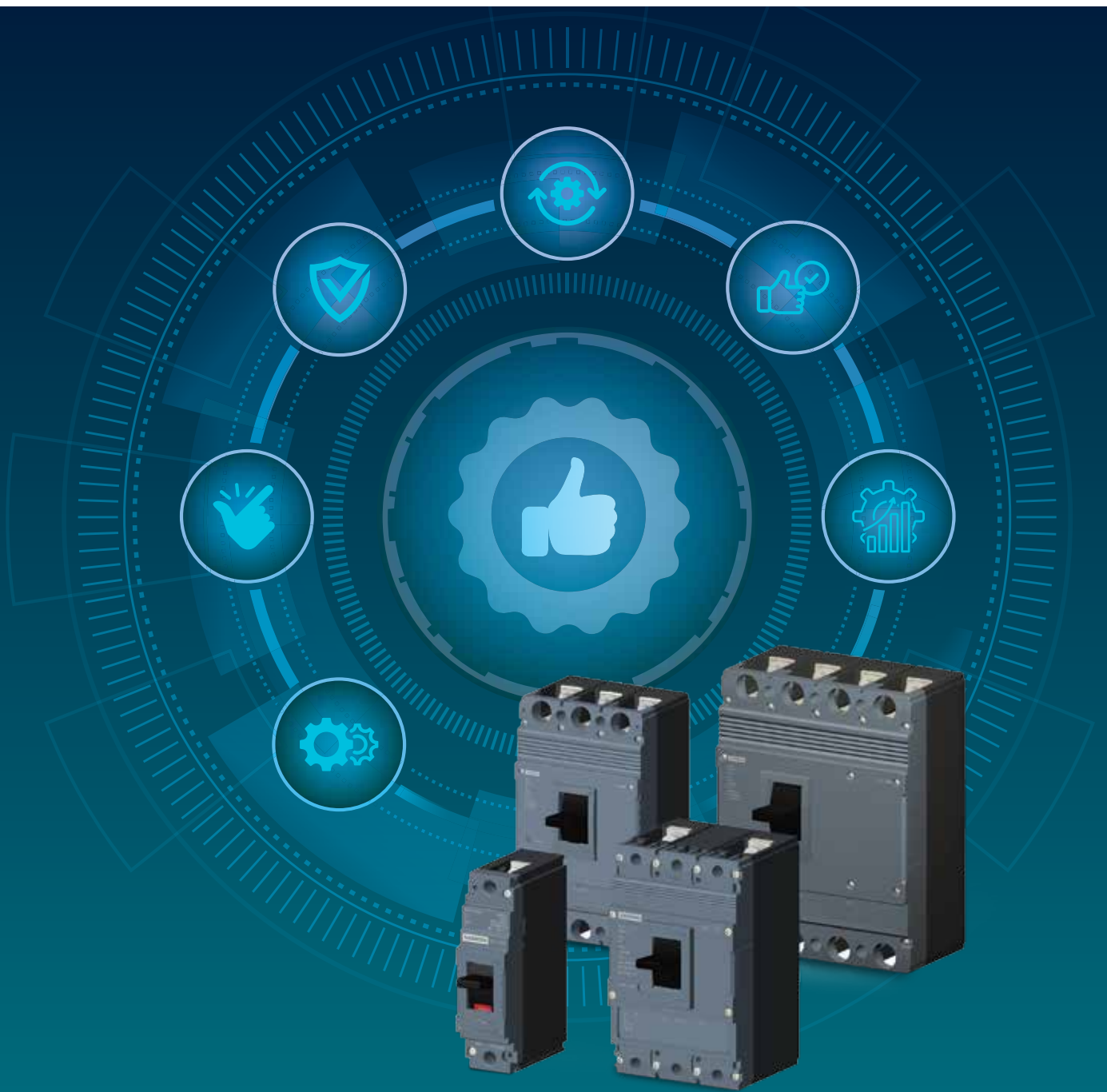

SINOPLUS

3VJ Moulded Case Circuit Breakers



- Rated current: 16A to 630A
- 1 pole, 2 pole, 3 pole & 4 pole versions
- Breaking capacity: 10kA to 55kA
- Thermal magnetic trip unit (FTFM, ATFM)
- Range of internal and external accessories

www.siemens.co.in

SIEMENS

3VJ Moulded Case Circuit Breakers^{\$}

3VJ MCCB, Thermal Magnetic Trip Unit, Fixed Thermal Fixed Magnetic (FTFM), 415V AC, 50Hz

Frame Size	Breaking Capacity @415V AC, 50/60Hz	Rated Current In (A)	3 Pole Type	4 Pole Type		
3VJ10 (VJ1 125X)	18kA	16	3VJ1096-1DA32-0AA0	3VJ1096-1EA42-0AA0		
		20	3VJ1002-1DA32-0AA0	3VJ1002-1EA42-0AA0		
		25	3VJ1092-1DA32-0AA0	3VJ1092-1EA42-0AA0		
		32	3VJ1003-1DA32-0AA0	3VJ1003-1EA42-0AA0		
		40	3VJ1004-1DA32-0AA0	3VJ1004-1EA42-0AA0		
		50	3VJ1005-1DA32-0AA0	3VJ1005-1EA42-0AA0		
		63	3VJ1006-1DA32-0AA0	3VJ1006-1EA42-0AA0		
		80	3VJ1008-1DA32-0AA0	3VJ1008-1EA42-0AA0		
		100	3VJ1010-1DA32-0AA0	3VJ1010-1EA42-0AA0		
		125	3VJ1012-1DA32-0AA0	3VJ1012-1EA42-0AA0		
		3VJ12 (VJ1 250)	25kA	16	3VJ1096-3DA32-0AA0	3VJ1096-3EA42-0AA0
				20	3VJ1002-3DA32-0AA0	3VJ1002-3EA42-0AA0
				25	3VJ1092-3DA32-0AA0	3VJ1092-3EA42-0AA0
				32	3VJ1003-3DA32-0AA0	3VJ1003-3EA42-0AA0
40	3VJ1004-3DA32-0AA0			3VJ1004-3EA42-0AA0		
50	3VJ1005-3DA32-0AA0			3VJ1005-3EA42-0AA0		
63	3VJ1006-3DA32-0AA0			3VJ1006-3EA42-0AA0		
80	3VJ1008-3DA32-0AA0			3VJ1008-3EA42-0AA0		
100	3VJ1010-3DA32-0AA0			3VJ1010-3EA42-0AA0		
125	3VJ1012-3DA32-0AA0			3VJ1012-3EA42-0AA0		
3VJ12 (VJ1 250)	25kA	160	3VJ1216-3DA32-0AA0	3VJ1216-3EA42-0AA0		
		200	3VJ1220-3DA32-0AA0	3VJ1220-3EA42-0AA0		
		250	3VJ1225-3DA32-0AA0	3VJ1225-3EA42-0AA0		

3VJ MCCB, Thermal Magnetic Trip Unit, Adjustable Thermal Fixed Magnetic (ATFM), 415V AC, 50Hz

Frame Size	Breaking Capacity @415V AC, 50/60Hz	Rated Current In (A)	3 Pole Type	4 Pole Type
3VJ10 (VJ1 125X)	25kA	16	3VJ1096-3DB32-0AA0	3VJ1096-3EB42-0AA0
		20	3VJ1002-3DB32-0AA0	3VJ1002-3EB42-0AA0
		25	3VJ1092-3DB32-0AA0	3VJ1092-3EB42-0AA0
		32	3VJ1003-3DB32-0AA0	3VJ1003-3EB42-0AA0
		40	3VJ1004-3DB32-0AA0	3VJ1004-3EB42-0AA0
		50	3VJ1005-3DB32-0AA0	3VJ1005-3EB42-0AA0
		63	3VJ1006-3DB32-0AA0	3VJ1006-3EB42-0AA0
		80	3VJ1008-3DB32-0AA0	3VJ1008-3EB42-0AA0
		100	3VJ1010-3DB32-0AA0	3VJ1010-3EB42-0AA0
		125	3VJ1012-3DB32-0AA0	3VJ1012-3EB42-0AA0
3VJ12 (VJ1 250)	25kA	160	3VJ1216-3DB32-0AA0	3VJ1216-3EB42-0AA0
		200	3VJ1220-3DB32-0AA0	3VJ1220-3EB42-0AA0
		250	3VJ1225-3DB32-0AA0	3VJ1225-3EB42-0AA0
3VJ13 (VJ1 400)	25kA	320	3VJ1332-3DB32-0AA0	3VJ1332-3EB42-0AA0
		400	3VJ1340-3DB32-0AA0	3VJ1340-3EB42-0AA0
3VJ11 (VJ1 125)	36kA	16	3VJ1196-5DB32-0AA0	3VJ1196-5EB42-0AA0
		20	3VJ1102-5DB32-0AA0	3VJ1102-5EB42-0AA0
		25	3VJ1192-5DB32-0AA0	3VJ1192-5EB42-0AA0
		32	3VJ1103-5DB32-0AA0	3VJ1103-5EB42-0AA0
		40	3VJ1104-5DB32-0AA0	3VJ1104-5EB42-0AA0
		50	3VJ1105-5DB32-0AA0	3VJ1105-5EB42-0AA0
		63	3VJ1106-5DB32-0AA0	3VJ1106-5EB42-0AA0
		80	3VJ1108-5DB32-0AA0	3VJ1108-5EB42-0AA0
		100	3VJ1110-5DB32-0AA0	3VJ1110-5EB42-0AA0
		125	3VJ1112-5DB32-0AA0	3VJ1112-5EB42-0AA0
3VJ12 (VJ1 250)	36kA	160	3VJ1216-5DB32-0AA0	3VJ1216-5EB42-0AA0
		200	3VJ1220-5DB32-0AA0	3VJ1220-5EB42-0AA0
		250	3VJ1225-5DB32-0AA0	3VJ1225-5EB42-0AA0
3VJ13 (VJ1 400)	36kA	320	3VJ1332-5DB32-0AA0	3VJ1332-5EB42-0AA0
		400	3VJ1340-5DB32-0AA0	3VJ1340-5EB42-0AA0
3VJ14 (VJ1 630)	36kA	630	3VJ1463-5DB32-0AA0	3VJ1463-5EB42-0AA0

^{\$} Kindly refer latest Power Distribution Products Price List for prices

3VJ Internal accessories⁵

Frame Size	Accessory compartment/ Coil voltage	3VJ10 (VJ1 125X)	3VJ11 (VJ1 125)	3VJ12 (VJ1 250)	3VJ13/14 (VJ1 400/630)
Auxiliary Switches (AUX)	Left	3VJ9018-0AN11	3VJ9218-0AN11	3VJ9218-0AN11	3VJ9417-0AN11
	Right	-	3VJ9218-0AN21	3VJ9218-0AN21	3VJ9417-0AN21
Auxiliary + Alarm Switches (AUX+AL)	Left	3VJ9018-0AD11	3VJ9118-0AD11	3VJ9218-0AD11	3VJ9417-0AD11
	Right	-	3VJ9118-0AD21	3VJ9218-0AD21	3VJ9417-0AD21

3VJ External accessories⁵

Frame Size	Accessory	3VJ10 (VJ1 125X)	3VJ11 (VJ1 125)	3VJ12 (VJ1 250)	3VJ13/14 (VJ1 400/630)
	Extended Door Mounted Rotary Operator (including 8UC handle)	3VJ9018-0HD11	3VJ9118-0HD11	3VJ9218-0HD11	3VJ9417-0HD11
	Enclosure	3VJ9016-0DE11 (2P, 3P)	3VJ9116-0DE11 (2P, 3P)	3VJ9216-0DE12 (2P, 3P)	-
		3VJ9014-0DE11 (4P)	3VJ9114-0DE11 (4P)	3VJ9214-0DE12 (4P)	-

**Raja⁺ DOL Starters[@]
3TW Direct On Line Starters**



3ph, 50Hz DOL Starter in sheet steel housing, including bimetal relay with single phasing protection

	Motor Rating At 415V 3ph 50Hz		Starter Type	Contactors	Thermal Overload Relay	Relay range (A)	Max. Full Load Current (Amp)		Std. Pkg. (Nos.)
	HP	kW					3Ph, 415V 4P Squirrel Cage IS 8789:1996 Table 4	3Ph, 415V 2P MRP Submersible motor IS 9283:1995 Table 2	
	0.33	0.25	3TW7291-1A^64	3TS3010-0A##-08KA0	3UW5102-0J	0.63-1	-	-	1
	0.75	0.55	3TW7291-1A^66	3TS3010-0A##-08KA0	3UW5102-1A	1-1.6	1.7	-	1
	1	0.75	3TW7291-1A^68	3TS3010-0A##-08KA0	3UW5102-1C	1.6-2.5	2.2	-	1
	1.5	1.1	3TW7291-1A^69	3TS3010-0A##-08KA0	3UW5102-1D	2-3.2	2.9	3.25	1
	2	1.5	3TW7291-1A^71	3TS3010-0A##-08KA0	3UW5102-1F	3.2-5	3.8	4.5	1
	3	2.2	3TW7291-1A^72	3TS3010-0A##-08KA0	3UW5102-1G	4-6.3	5.1	6.5	1
	5	3.7	3TW7291-1A^74	3TS3010-0A##-08KA0	3UW5102-1J	6.3-10	8.1	10	1
	7.5	5.5	3TW7291-1A^75	3TS3210-0A##-08KA0	3UW5102-1K	8-12.5	11.4	14.5	1
	7.5	5.5	3TW7291-1A^77	3TS3210-0A##-08KA0	3UW5102-2A	10-16	-	-	1
	10	7.5	3TW7291-1A^78	3TS3210-0A##-08KA0	3UW5102-2B	12.5-20	15.4	19.5	1

^ Enter code for coil voltage, 50Hz (B for 200-400V AC, W for 332 - 456V AC)

Enter Code for operating coil voltage, 50 Hz (Z6 for 200-400V, R0 for 415V)

* MRP - Maximum Retail Price LP - List Price

\$ Kindly refer latest Power Distribution Products Price List for prices

@ Kindly refer latest Control Products Price List for prices

Switch disconnecter fuse[@] Superswitch 3KL8 in open execution 3PN

Switch Disconnector fuse: 3KL8 for power distribution (in Open Execution 3PN)[^]

	Rated current Ie @ 690V AC 50Hz	SDF suitable for DIN type HRC Fuses	SDF suitable for BS type HRC Fuses	SDF suitable for cylindrical type HRC Fuses	Std. pkg. (nos.)
	20A	3KL8111-5TA00	3KL8111-5TJ00	3KL8111-5TC00	1
	32A	3KL8121-5TA00	3KL8121-5TJ00	3KL8121-5TC00	1
	63A	3KL8151-5TA00	3KL8151-5TJ00	3KL8151-5TC00	1
	100A	3KL8171-5TA00	-	-	1
	100A	3KL8211-5TA00	3KL8211-5TJ00	-	1
	125A	3KL8221-5TA00	3KL8221-5TJ00	-	1
	160A	3KL8231-5TA00	3KL8231-5TJ00	-	1
	200A	3KL8311-5UA00	3KL8311-5UJ00	-	1
	250A	3KL8321-5UA00	3KL8321-5UJ00	-	1
	315A	3KL8331-5UA00	3KL8331-5UJ00	-	1
	400A	3KL8341-5UA00	3KL8341-5UJ00	-	1
	500A	3KL8411-5UA00	3KL8411-5UJ00	-	1
	630A	3KL8421-5UA00	3KL8421-5UJ00	-	1
	800A	3KL8431-5UA00	3KL8431-5UJ00	-	1

[^] 3PN is 3 Pole with neutral link

Selection table for SS Housing for 3KL8



	Rated current Ie (A)	Reference No	Unit MRP* ₹	Std. Pkg. (Nos.)
	3KL81 (20A - 63A)	3KX8235-4AC	-	1
	3KL82 (100A - 160A)	3KX8235-4AC	-	1
	3KL83 (200A - 400A)	3KX8345-4AC	-	1
	3KL84 (500A - 800A)	3KX8435-4AC	-	1

Rated current Ie (A)	Gland box Reference No.	Unit MRP* ₹	Gland Plate Reference No.	Unit MRP* ₹	Std Pkg. (Nos.)
3KL81(20A-63A)	3KX8235-4DC	-	3KX8235-4GC	-	1
3KL82(100A-160A)	3KX8235-4DC	-	3KX8235-4GC	-	1
3KL83(200A-400A)	3KX8345-4DC	-	3KX8345-4GC	-	1
3KL84(500A-800A)	3KX8435-4DC	-	3KX8435-4GC	-	1

LV HRC Fuses[@]

DIN Type Fuse



Rated voltage: 500 V AC

	Size	Rated current A	Reference No	Unit MRP* ₹	Std. Pkg. (Nos.)
	000	2	3NA7 802-ORC	-	1/6
		4	3NA7 804-ORC	-	
		6	3NA7 801-ORC	-	
		10	3NA7 803-ORC	-	
		16	3NA7 805-ORC	-	
		20	3NA7 807-ORC	-	
		25	3NA7 810-ORC	-	
		32	3NA7 812-ORC	-	
		40	3NA7 817-ORC	-	
		50	3NA7 820-ORC	-	
	00	63	3NA7 822-ORC	-	
		80	3NA7 824-ORC	-	
		100	3NA7 830-ORC	-	
	1	125	3NA7 832-ORC	-	
		160	3NA7 836-ORC	-	
		50	3NA7 120-ORC	-	1/3
		63	3NA7 122-ORC	-	
		80	3NA7 124-ORC	-	
		100	3NA7 130-ORC	-	
		125	3NA7 132-ORC	-	
		160	3NA7 136-ORC	-	
		200	3NA7 140-ORC	-	
		224	3NA7 142-ORC	-	
250	3NA7 144-ORC	-			

400 & 800A fuses - Rated voltage at 415 V AC

Note: * MRP - Maximum Retail Price

@ Kindly refer latest Power Distribution Products Price List for prices



	Size	Rated current A	Reference No	Unit MRP* ₹	Std. Pkg. (Nos.)
	2	200	3NA7 240-ORC	-	1/3
		250	3NA7 244-ORC	-	
		315	3NA7 252-ORC	-	
		400 [#]	3NA7 260-ORC	-	
	3	315	3NA3 352-ORC	-	1/3
		400	3NA3 360-ORC	-	
		500	3NA3 365-ORC	-	
		630	3NA3 372-ORC	-	
		800 [#]	3NA3 375-4RC	-	

BS Fuses

	Type	Rated current A	Reference No	Unit MRP* ₹	Std. Pkg. (Nos.)
	Offset Tag	2	3NW TIA2	-	20
		4	3NW TIA4	-	
		6	3NW TIA6	-	
		10	3NW TIA10	-	
		16	3NW TIA16	-	
		20	3NW TIA20	-	
		25	3NW TIA25	-	
		32	3NW TIA32	-	
		40	3NW TIS40	-	
		50	3NW TIS50	-	
		63	3NW TIS63	-	

Available till stocks last

**Betagard Distribution Boards
8GB31**

	Item Description	Incoming Slots (MW)	Outgoing Slots (MW)	Total Slots (MW)	Reference No	Unit MRP* ₹	Std. Pkg.** (Nos.)
Betaflex (Flexi DBs), IP42 :							
	2Row x 12Mod	—	—	24	8GB31424RC	Price on request	1
	2Row x 16Mod	—	—	32	8GB31426RC		1
	4Row x 6Mod	—	—	24	8GB31441RC		1
	4Row x 8Mod	—	—	32	8GB31442RC		1
	4Row x 10Mod	—	—	40	8GB31443RC		1
	4Row x 12Mod	—	—	48	8GB31444RC		1
	4Row x 16Mod	—	—	64	8GB31446RC		1
Betabus (Vertical Busbar DBs with MCB as an incomer), IP42 : (Suitable for 5SL/5SP MCBs, upto 125A as an incomer)							
	4 way	12	12	24	8GB31471RC	Price on request	1
	6 way	12	18	30	8GB31473RC		1
	8 way	12	24	36	8GB31474RC		1
	12 way	12	36	48	8GB31477RC		1
Betabusplus (Vertical Busbar DBs with MCCB as an incomer), IP42 : (Suitable for 3VT1/3VA1 MCCBs, upto 160A as an incomer)							
	4 way	12	12	24	8GB31571RC	Price on request	1
	6 way	12	18	30	8GB31572RC		1
	8 way	12	24	36	8GB31573RC		1
	12 way	12	36	48	8GB31574RC		1
BetaMulti (DBs for power & communication), IP42 :							
	12 way SPN, provision	2	12	14	8GB31215RC	Price on request	1
	4 Way TPN, Provision	8	12	20	8GB31220RC		1
	6 way TPN, provision	8	18	26	8GB31221RC		1
	8 Way TPN Provision	8	24	32	8GB31222RC		1

Note:





* MRP - Maximum Retail Price

** Purchase MOQ for our authorized dealers is in multiples of standard packing, contact Siemens Sales Office for further details

Available till stocks last

Available till stocks last

Betagard Distribution Boards 8GB31

	Item Description	Incoming Slots (MW)	Outgoing Slots (MW)	Total Slots (MW)	Reference No	Unit MRP* ₹	Std. Pkg.** (Nos.)
Beta CO (DBs with built-in pre-wired phase changeover switches), IP42 :							
	40 A, 4 Way TPN, built-in	8	12	20	8GB31850RC	Price on request	1
	40 A, 6 Way TPN, built-in	8	18	26	8GB31851RC		1
	40 A, 8 Way TPN, built-in	8	24	32	8GB31852RC		1
	40 A, 12 Way TPN, built-in	8	36	44	8GB31854RC		1
	63 A, 4 Way TPN, built-in	8	12	20	8GB31860RC		1
	63 A, 6 Way TPN, built-in	8	18	26	8GB31861RC		1
	63 A, 8 Way TPN, built-in	8	24	32	8GB31862RC		1
	63 A, 12 Way TPN, built-in	8	36	44	8GB31864RC		1
Wire Way Boxes (WWB)							
	WWB for Flexi DB, 8Mod	—	—	—	8GB9908FWWNT	Price on request	1/5
	WWB for Flexi DB, 12Mod	—	—	—	8GB9912FWWNT		1/5
	WWB for Flexi DB, 16Mod	—	—	—	8GB9916FWWNT		1/5
	WWB for Bus DB	—	—	—	8GB99BUSWWNT		1/5
	WWB for Bus Plus DB	—	—	—	8GB99PLUSWWNT		1/5
Modular Device Boxes (MDB)							
	MDB for Flexi DB, 8Mod/Row	—	—	8	8GB9908FMDTC	Price on request	1/5
	MDB for Flexi DB, 12Mod/Row	—	—	12	8GB9912FMDTC		1/5
	MDB for Flexi DB, 16Mod/Row	—	—	16	8GB9916FMDTC		1/5
	MDB for Bus DB	—	—	12	8GB99BUSMBTC		1/5
	MDB for Bus Plus DB	—	—	12	8GB99PLUSMBTC		1/5
BetaMulti (DBs for power & communication), IP42 :							
	12 way SPN, built-in	2	12	14	8GB31315RC	Price on request	1
	4 Way TPN, Built-in	8	12	20	8GB31320RC		1
	6 way TPN, built-in	8	18	26	8GB31321RC		1
	8 Way TPN, Built-in	8	24	32	8GB31322RC		1
Beta CO (DBs with provision for phase changeover switches), IP42 :							
	4 way, with provision	8	12	20	8GB31840RC	Price on request	1
	6 way, with provision	8	18	26	8GB31841RC		1
	8 way, with provision	8	24	32	8GB31842RC		1
	12 way, with provision	8	36	44	8GB31844RC		1

Betagard Distribution Boards Accessories

	Item Description	Reference No	Unit MRP* ₹	Std. Pkg.** (Nos.)
Blanking Plate				
	1.5 MW	8GB9902	Price on request	25

Note:

* MRP - Maximum Retail Price

** Purchase MOQ for our authorized dealers is in multiples of standard packing, contact Siemens Sales Office for further details

Discontinued Products

Betagard Circuit Breakers 5SY4, with C characteristics

Reference No.	Reference No.
5SY41807CC 5SY42807CC	5SY43807CC 5SY44807CC

Modular Devices

Reference No.	Reference No.	Reference No.
5TE8161 5TE8162 5TE8142	5TT58000 5TT58006 5TT58016	5TT58306

Terms and Conditions

Maximum Retail Price (MRP) / List Price (LP) is subject to revision without prior notice.

The company reserves the right to supply goods at its works or godown at its discretion.

The minimum order size for non-stock items (items not marked with ) is 50 Nos. for each item or ₹ 50,000/- per item.

Export control regulation - retention clause: The fulfillment of the agreement on Siemens part is subject to the provision that this shall not be prevented by implements on the grounds of national and international legal requirements, in particular export control provision.

Stock items

The normal stock items (indicated by ) are subject to change without prior notice.

Note

- This supercedes all previous Price Lists.
- List Prices (LPs) mentioned are exclusive of all taxes.
- Maximum Retail Prices (MRPs) mentioned in the publication are maximum recommended selling prices.
- Invoice amount not to exceed MRP
- Invoice amount = MRP (less) applicable discount + applicable GST %
- For receiving material in factory sealed packing, we request you to order in multiples of the indicated standard packing quantity.

Ask your nearest Siemens partners to include you in our mailing list.

Always make your purchases only from our authorized dealers. Details available with our sales office/territory managers.



7KT PAC1200

Multichannel current measuring system for flexible multichannel monitoring in final distribution

Current Sensors

- Versions: 40 A, 63 A

Sensor Bar

- Versions available for 3, 6, 9, 12

Data Manager

- Connection of up to 96 sensors (40A/63A)
- DIN rail installation (4MW)

Communication/ Software:

- Modbus TCP/ IP
- Simple system onfiguration via web server
- Easy access to energy data with mobile app (iOS/Android)

*For more details, contact nearest Siemens Sales Office

siemens.com/powermonitoring

SIEMENS

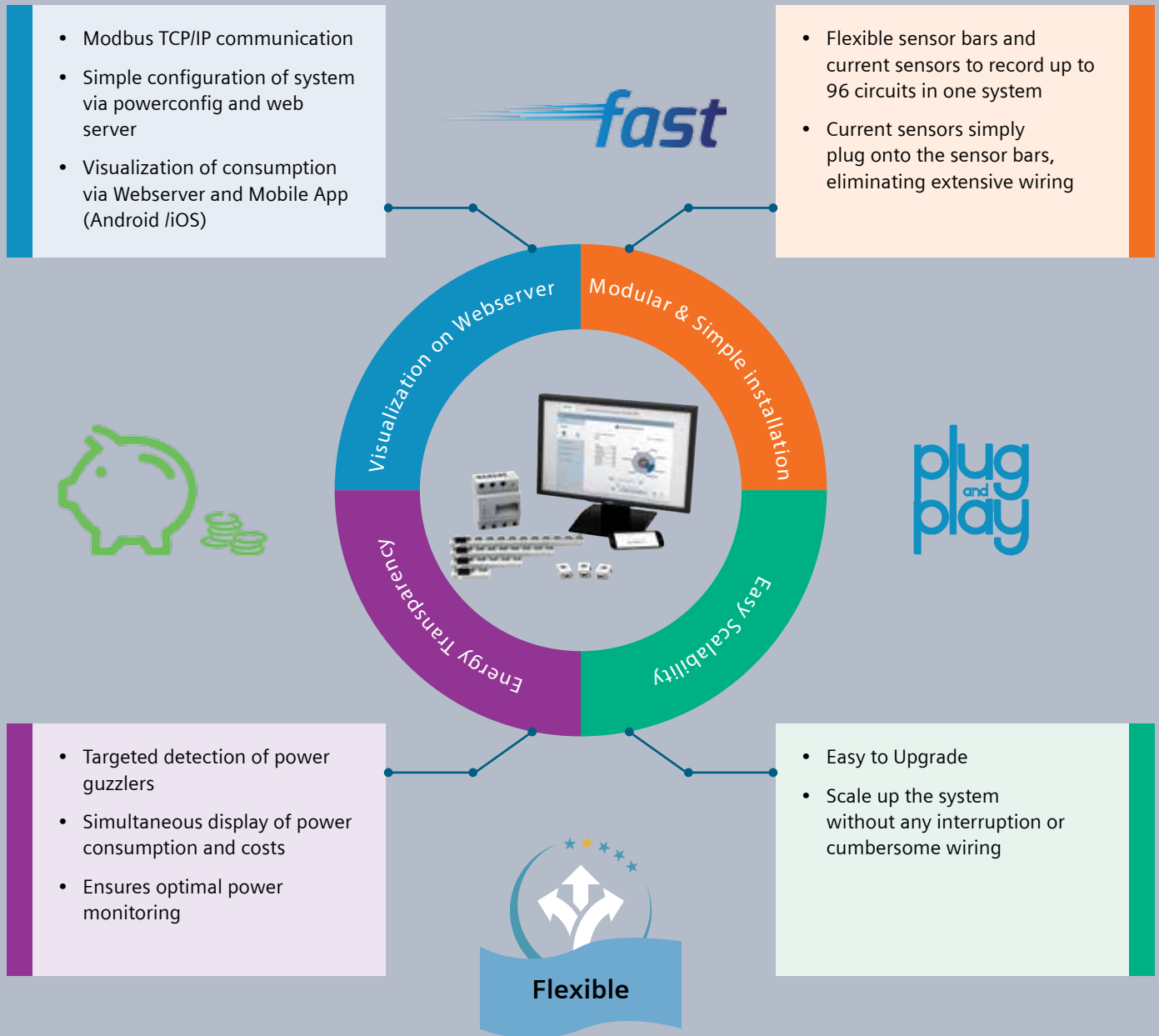

Easy



Transparent



Cost-efficient



Relevant Standards

Title	IS	IEC	Products							
			MCB		RCCB		RCBO	DB	AFDD	SPD
			5SL4/6/7	5SL5	5SV	5SM	5SU1	8GB	5SM6	5SD7
Electric Installations – MCBs for Building Installations and Similar Purposes Part 1: MCBs for AC Systems	IS 60898-1	IEC 60898-1	✓	–	–	–	–	–	–	–
Low-voltage switchgear and controlgear Part 2: Circuit-breakers	IS 60947-2	IEC 60947-2	–	✓	–	–	–	–	–	–
Residual Current Operated Circuit-Breakers for Household and Similar Uses, Part 1: Circuit-Breakers Without Integral Overcurrent Protection (RCCBs)	IS 12640-1	IEC 61008-1	–	–	✓	✓	–	–	–	–
Residual Current Operated Circuit-Breaking for Household and Similar Uses, Part 2: Circuit-Breakers with Integral Overcurrent Protection (RCBOs)	IS 12640-2	IEC 61009-1	–	–	–	–	✓	–	–	–
General requirements for arc fault detection devices	–	IEC 62606	–	–	–	–	–	✓	–	–
Low-voltage switchgear and controlgear assemblies, Part 2: Power switchgear and controlgear assemblies	–	IEC 61439-1/3	–	–	–	–	–	✓	–	–
Surge protective devices connected to low-voltage power systems	–	IEC 61643-11	–	–	–	–	–	–	–	✓



Degree of Protection

First digit: Protection against solid foreign objects		Second digit: Protection against ingress of water	
	0 No protection		0 No protection
	1 Protected against solid objects up to 50mm (e.g. hand)		1 Protection against vertically falling drops of water (e.g. condensation)
	2 Protected against solid objects up to 12mm diameter (e.g. finger)		2 Protection against direct sprays of water up to 15 degrees from vertical
	3 Protected against solid objects up to 2.5mm diameter (e.g. screwdriver)		3 Protection against direct sprays of water up to 60 degrees from vertical
	4 Protected against solid objects up to 1mm diameter (e.g. wire)		4 Protection against water sprayed from all directions, limited ingress permitted
	5 Protected against dust: limited ingress permitted, no harmful deposit.		5 Protected against low-pressure jets of water from all directions, limited ingress permitted
	6 Totally protected against dust		6 Protected against strong jets of water from all directions, limited ingress permitted (e.g. water from heavy seas on a ship's deck)
			7 Protected against the effect of temporary immersion (30 min) between 15cm and 1m
			8 Protected against long period of immersion under pressure
			9 Protected against high pressure, high temperature jets of water from multiple directions

IP 6 8



Installation Guideline for RCCB

RCCB suitability for various distribution networks.

Betagard RCCBs can be used in all 3 distribution network types viz. TN, TT & an IT network system. 4 pole RCCBs can also be used in 3 pole supply networks by adhering to installation guidelines. In this case, connection must be at terminals 1, 3 and 5 and 2, 4 and 6.

The function of the test equipment is only ensured if a jumper is fitted between terminals 3 and N.

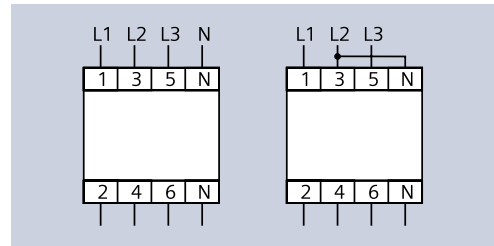

Types and waveform

					6 mA	10 mA		
Type AC		■	-	-	-	-	-	-
Type A		■	■	■	■	-	-	-
Type F		■	■	■	■	■	■	-
Type B		■	■	■	■	■	■	■
Type B+		■	■	■	■	■	■	■

Version

SIGRES	with active condensation protection for use in severe ambient conditions
[G] / [K]	super-resistant, 10 ms short-term delayed devices with increased immunity to false triggering due to transient disruptions
[S]	as an upstream group switch for selective shutdown against downstream RCCBs



Installation locations for Surge Protection Devices (SPDs)

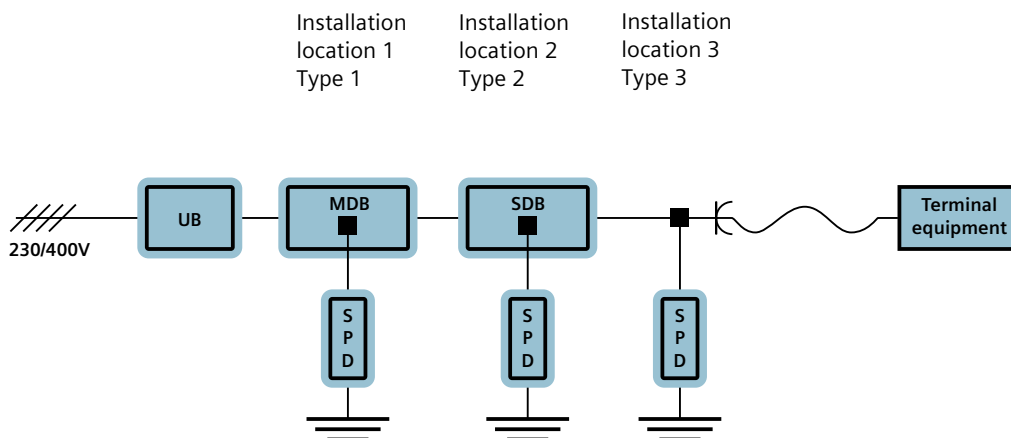

UB: Utility Box

MDB: Main distribution board

SDB: Sub Distribution board

Installation location 1 must be as close as possible to the supply point for the electrical system, so that the downstream installations are protected. The SPDs at installation locations 2 and 3 shall not be used without SPDs at installation location 1, and they must be coordinated with these SPDs (i.e. SPDs all from the same manufacturer).

One point contact for your service needs

The comprehensive range of services from Siemens is sure to cover the needs of the most varied users. We offer structured

services, designed to give you valuable support in every phase during the lifecycle of your Final Distribution Products.

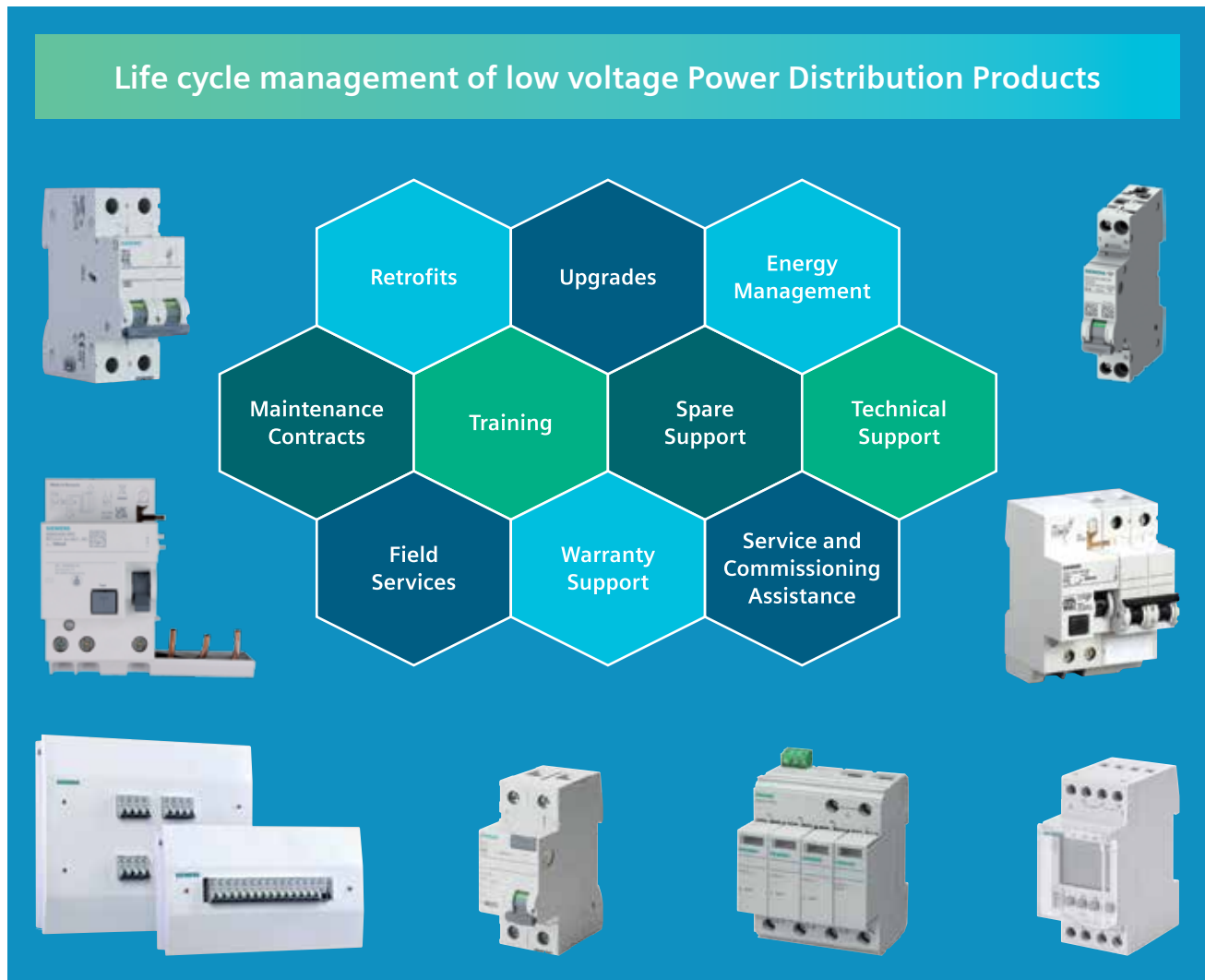

Please contact us for more details

CUSTOMER CARE

Toll Free No: 1800220987 / 18002090987 • E-mail: ics.india@siemens.com

Customer care

One stop support for all service needs:

- Breakdown service
- Annual maintenance contracts
- Retrofit solutions
- Spares
- Digitalization & Panel retrofits

For more details please contact:

Customer care desk

Siemens Limited

R&D Technology Centre

Thane Belapur Road, Airoli Node, Navi Mumbai - 400708

For more information contact toll free 1800 209 1800

Tel.: 022-27600150 • Fax: 022-33265381

<http://support.automation.siemens.com/in>

Your partners

Sales offices:

Ahmedabad

3rd Floor, Prerna Arbour, Chimanlal Girdharlal Road
Navrangpura, Near Girish Coldrinks
Ahmedabad, Gujarat - 380009
Tel: +91 79 30927600
Mobile: +91 9925001779
E-mail: chandrakant.keshrani@siemens.com

Baroda

1st Floor Ishan Building, Sarabhai Campus
Beside Neptune Edge Building, Subhanpura
Vadodara, Gujarat - 390023
Mobile: +91 9429037805
E-mail: kalpeshkumar.darji@siemens.com

Bengaluru

2nd Floor, Jyoti Mahal, No. 49, St. Marks Road
Bengaluru - 560001
Tel: +91 80 33422000
Mobile: +91 988003710
E-mail: gauri.menoky@siemens.com

Bhubaneswar

Plot No. 3462, Kalipleswar Vihar Lane 3, Palasuni
Bhubaneswar, Odisha - 751010
Mobile: +91 8696222212
E-mail: rohit.nandan@siemens.com

Chandigarh

Flat No. 804, Tower 20, Motiaz Royal Citi, Punjab - 140603
Mobile: +91 9888484066
E-mail: padam.sharma@siemens.com

Territory managers:

Belgaum

Mobile: +91 7483502752
E-mail: swapnil.adure@siemens.com

Bharuch

Bungalow No. 1, Sanskar Villa, Behind Yogi Petrol Pump
Narmada Chokdi, Zadeshwar, Bharuch - 392011
Mobile: +91 8884000998
E-mail: viral.kachhadia@siemens.com

Bhopal

D-3 Pebble Bay Phase 2, Bagmugaliya, Near IVY Global School
Bhopal - 462043, Madhya Pradesh
Mobile: +91 9926415756
E-mail: taxmi-narayan.dhakar@siemens.com

Boisar

E-Mail: abhijit-prabhakar.salvi@siemens.com
Mobile: +91 9833905666

Chhatrapati Sambhaji Nagar (Aurangabad)

Mobile: +91 8087742504
E-Mail: vyankatesh.shendge@siemens.com

Cochin

E27, Federal Park, Vennala PO, Ernakulam - 682028
Mobile: +91 9447313241
E-mail: max.tom@siemens.com

Guwahati

Shivalaya Housing Society, Flat No. B-3A, Bylane 4
Jyomatnagar, Adabari, Pandu, Guwahati - 781012, Assam
Mobile: +91 9864110684
E-mail: biplab.datta@siemens.com

Haridwar

41, Green Estate Phase- II
A2Z, Muzaffarnagar, Uttar Pradesh - 251001
Mobile: +91 9953256270
Email: vinod.nishad@siemens.com

Indore

202-Orion Grand, 02-Sampat Kalyan Orchid, Bhawrasla
Indore, Madhya Pradesh - 453555
Mobile: +91 9274024196
E-mail: shripad.nair@siemens.com

Jalandhar

H.No. 212A, Punjabi Bagh Extn, Near Curo Mall
Jalandhar - 144001, India
Mobile: +91 9876047929
E-mail: sunil.singla@siemens.com

Kolhapur & Goa

Krushna Krupa Lake View, Flat No. 403
Jivba Nana Jadhav Road, Kolhapur - 416007
Mobile: +91 9970961852
E-mail: Jivan.kesarkar@siemens.com

Kota

A-1, 1st Floor, Shrinath Estate, Railway Station Road
Kota - 324002, Rajasthan
Mobile: +91 9929110493
E-mail: rajendra.kabra@siemens.com

Siemens Limited

Smart Infrastructure

Electrical Products

R&D Technology Centre

Thane Belapur Road

Airoli Node, Navi Mumbai - 400708

For more information contact toll free

1800 209 1800

E-mail: lvsg-rmktg.india@siemens.com

www.siemens.co.in

Chennai

4th Floor, ETA Mount Central, Seethakathi Business Centre
Mount Road, Chennai - 600006
Tel: +91 44 30474000
Mobile: +91 9176609375
E-mail: muthu.kumar@siemens.com

Coimbatore

Regus, 6th Floor, Hanudev Infopark, Udayampalayam Main Rd.
Nava India Rd., Coimbatore - 641028
Mobile: +91 8754403663
E-mail: ragesh.subramanian@siemens.com

Delhi / Gurgaon

DLF Cyber Park, Tower B, 10th Floor, Plot No. 405B
Udyog Vihar Phase-II, Gurugram - 122008, India
Mobile: +91 9971091588
E-mail: manjeet.mor@siemens.com

Hyderabad

5-9-19, 4th Floor, Lakshmi Narasinh Estate, Hyderabad - 500004
Tel: +91 40 29390089
Mobile: +91 9167527072
E-mail: kumar.cvs@siemens.com

Jaipur

Jaipur Centre Mall, Regus, 6th Floor, Cabin No. 633
Tonk Road, Jaipur - 302017
Mobile: +91 9818099433
E-mail: rajesh.raina@siemens.com

Ludhiana

House No. 91, Lane 25, Bhagya Homes
Rahon Road, Ludhiana - 141007, India
Mobile: +91 9872419990
E-mail: ravinder.pal@siemens.com

Madurai

B6, 17th Avenue Gladway Greencity
Avaniyapuram, Madurai - 625012
Mobile: +91 8667482574
E-mail: s.bhuvanesh.kanth@siemens.com

Nagpur

Plot No. 117, 118, 119, Flat No. 202, Yatharth Apartment
Mahalaxmi Society, Manish Nagar, Nagpur - 440015
Mobile: +91 9049610003
E-mail: sanjay.lonkar@siemens.com

Nashik

103, Aravalli Co-Housing Soc., Near Mahila Bank
Indira Nagar, Nashik - 422009
Mobile: +91 9822193204
E-mail: mayur.kulkarni@siemens.com

Patna

Road No-12A, Keshri Nagar, Near Veer Kunwar Singh Chowk
Patna - 800024
Mobile: +91 70701 92127
E-mail: kumar.rk.rakesh@siemens.com

Pondicherry & Trichy

First Floor, No. 4, Second Street, Kamban Nagar
Reddiarpalayam, Puducherry - 605010
Mobile: +91 9840255185
E-mail: r.pradeep@siemens.com

Raipur - 1

Jr. M.I.G 601, Chilpy Height, Bhawna Nagar
Near Shankar Nagar, Raipur - 492007
Mobile: +91 8823823438
E-mail: ashutosh-singh@siemens.com

Raipur - 2

Jr. M.I.G 503, Chilpy Height, Bhawna Nagar
Near Shankar Nagar, Raipur - 492007
Mobile: +91 9926511479
E-mail: ravindra.ughade@siemens.com

Rajkot

Flat No. 204, D Wing, Icon Platinum, Opp. Rani Residency
Behind Ayurvedik Hospital, University Road
Gujarat, Rajkot - 360005
Mobile: +91 9875038983
E-mail: jigneshkumar.dalsaniya@siemens.com

Ranchi

Astha Regency, Block-A, Flat No. 805, 8th Floor
Ratu Pandra Road, Piska More, PS-Sukhdeo Nagar
Ranchi, Jharkhand - 834005
Mobile: +91 7033537344
E-mail: soumitra.dutta@siemens.com

Jamshedpur

House No. 104, TISCO Society, Near Sani Mandir, Opposite IDTR
Adityapur, Jamshedpur, Jharkhand - 832109
Mobile: +91 8697629687
E-Mail: arka.paul@siemens.com

Kolkata

1st Floor, 43, Shanti Palli, Rashbihari Bypass Connector
Kolkata - 700042
Tel: +91 33 30939000
Mobile: +91 9051015666
E-mail: amarnath.karmakar@siemens.com

Lucknow

B-121/5, Indira Nagar, Lucknow, Uttar Pradesh - 226016
Mobile: +91 9918002525
E-mail: atul.shukla@siemens.com

Mumbai

Business Centre - 1
Kalwa Works, Thane Belapur Road, Airoli, Navi Mumbai - 400708
Tel: +91 22 39663000
Mobile: +91 9822467311
E-mail: abhijeet.dandekar@siemens.com

Pune

Tower C, Panchshil Business Park, Survey No. 20, Balewadi
Pune - 411045
Tel: +91 20 30466000
Mobile: +91 9983691888
E-mail: anurag.shah@siemens.com

Rourkela

U4/8, Civil Town Ship, Near Sailap Hospital
Rourkela - 769004
Mobile: +91 9861056581
E-mail: ashirbad.das@siemens.com

Rudrapur

Village – Nawar – Khera
Saheed Rajendra Singh Bhakuni Marg, PO - Kathgodam, Golapar
Haldwani - Distt Nainital, Uttarakhand - 263126
Mobile: +91 9839174578
E-mail: girish.pandey@siemens.com

Sonepat & Panipat

House No. 21, Virk Nagar, Near Sant Nagar
Nirankari Bhawan, Panipat - 132103
Mobile: +91 9911316981
E-mail: mohit.bisaria@siemens.com

Sricity

No. 84, Bazaar Street, Thandalam, Near Periyapalayam
Thiruvallur - 601102
Mobile: +91 9789824823
E-Mail: rvikram@siemens.com

Sriperumbudur

No. 205, H Block, KG Centre Point, Palanjur Road
Chembarambakkam, Kanchipuram - 600123
Mobile: +91 944622236
E-mail: arshath.b@siemens.com

Surat

House No.12, Suvarnaraj Society, Opp. Nova Apex Apartments
Near Gantawala Panshop, Adajan, Surat - 395009
Mobile: +91 9904717949
E-mail: dhaval.tailor@siemens.com

Udaipur

E45, Sector 14, Behind Capital Tower
Udaipur - 313002, Rajasthan
Mobile: +91 8003088889
E-mail: ankur.pancholi@siemens.com

Vapi

Mobile: +91 8655512139
E-mail: deepak.gorad@siemens.com

Varanasi

Vrindavan Residency, Nuaon Bypass
Tikari Road, Dafi, Varanasi - 221011 (U.P.)
Mobile: +91 9984500021
E-mail: kumardeepak@siemens.com

Vijayawada

Mobile: +91 9966637966
E-mail: lakshmi-narayana.ramineni@siemens.com

Vizag

Mobile: +91 9849323838
E-mail: sivadurgaprasad.mondeti@siemens.com

Order No.: 115840026

SI-EP-CC-DIPL-032026

(This replaces SI-EP-CC-DIPL-102025

dated 1 November, 2025)

Customer Care Toll free no. 1800 209 0987

Email: ics.india@siemens.com

Product upgradation is a continuous process. Hence, data in this pricelist is subject to change without prior notice. For the latest information, please get in touch with our Sales Offices.